

UNITED STATES DISTRICT COURT
SOUTHERN DISTRICT OF NEW YORK
-----X
REGENERON PHARMACEUTICALS, :
INC., :
: :
Plaintiff, :
Counterclaim-Defendant, :
: :
-v- :
: :
MERUS B.V., :
: :
Defendant, :
Counterclaim-Plaintiff. :
----- X

USDC SDNY DOCUMENT ELECTRONICALLY FILED DOC #: _____ DATE FILED: <u>November 2, 2015</u>
--

14 Civ. 1650 (KBF)

OPINION & ORDER

KATHERINE B. FORREST, District Judge:

On March 11, 2014, Regeneron filed twin patent infringement actions: one against Merus B.V. (“Merus”), a company based in the Netherlands, and another against Ablexis LLC (“Ablexis”). (See ECF No. 1.) In short complaints, each consisting of a few substantive paragraphs, Regeneron accused both companies of infringing U.S. Patent No. 8,502,018 (“’018 Patent”).¹ Merus answered and counterclaimed, arguing that the ‘018 Patent was unenforceable due to Regeneron’s conduct during patent prosecution. (See ECF Nos. 72, 225.) This litigation ensued. Following issuance of this Court’s opinion on claim construction, (ECF No. 210) Regeneron stipulated that its infringement claim as to Merus² must fail if the Court’s constructions withstand challenge on appeal. (ECF No. 271.) Thereafter,

¹ Merus moved to dismiss the complaint as failing to fulfill basic notice requirements set forth in Rule 8 of the Federal Rules of Civil Procedure and the standard set out by the Supreme Court in Bell Atlantic Corp. v. Twombly, 550 U.S. 544 (2007). Though agreeing that the complaint was sparse, the Court nonetheless found it was minimally sufficient and denied the motion. (ECF No. 71.)

² Ablexis settled with Regeneron prior to claim construction.

all that remained was Merus's counterclaim for inequitable conduct. On June 9-15, 2015 the Court held a bench trial on that claim. Set forth below are the Court's findings of fact and conclusions of law.

Based on substantial evidence adduced at trial – as well as certain instances of Regeneron's litigation conduct – it is clear that this litigation should never have been commenced. It is not unusual for one litigant to argue as much at the outset of a case, but it is much rarer for the evidence to prove it to be true. It is true here. Throughout the history of this case Regeneron has sought to discover how it needed to define its invention to have it fit a cognizable theory of infringement; it has had to contort science, the documentary record, and an alleged commercial embodiment to make them fit the framework of a specification that described a far broader, not as useful, and possibly altogether different invention; and it has demonstrated that the invention disclosed in the '018 Patent is not the same as that Regeneron described during prosecution to the U.S. Patent & Trademark Office ("PTO"). As it turns out, the invention that Regeneron's technical expert, Marjorie A. Oettinger, Ph.D., described is interesting and might in fact lead to the discovery of therapeutically useful antibodies, but it is simply not the invention disclosed in the '018 Patent.

It is unfortunate that this case has been marked by troubling litigation tactics, and doubly so as the purpose of this final proceeding was to determine whether Regeneron had engaged in inequitable conduct or affirmative egregious misconduct during patent prosecution. Troubling litigation tactics were on display

soon after this case was filed and continued into the trial. Based upon the Court's assessment of the evidence, it appears that the very birth of this patent was beset by misconduct as well. And so it has come full circle. That which was obtained by misconduct ends as a result of misconduct.

I. THE '018 PATENT

Regeneron's '018 Patent is the subject of this proceeding. Entitled "Methods of Modifying Eukaryotic Cells," it is one of a number of patents and/or related patent applications in the same family and sharing some or all of the same specification. (See '018 Patent,³ "Related U.S. Application Data.") The original application to which the '018 Patent traces back was initially filed on February 16, 2001. (Id.) As discussed in several parts of this Opinion, this date – February 16, 2001 – plays an important role in defining the invention; that is, in determining what it is and what it simply cannot be.

Regeneron describes the invention disclosed in the Patent as a mouse with normal immune response useful for discovering therapeutic antibodies. According to Regeneron, mice described by prior art had deficient immune response. The invention involves, in part, the targeted insertion of unrearranged human variable region DNA segments into an endogenous mouse (murine⁴) immunoglobulin ("Ig") locus. According to Regeneron, this would result in a mouse with human variable

³ The '018 Patent is PX 1.

⁴ Of, relating to, or involving mice.

regions and mouse constant regions, that is, a “chimeric” or “reverse chimeric”⁵ mouse. Notably, and as described further below, Regeneron’s view of the invention necessarily presumes a multi-step process. The process could unfold in two different ways. It could be achieved by making two targeted insertions into the same mouse Ig loci, one of human heavy chain variable regions and a subsequent and further targeted insertion of human light chain variable regions. Or, alternatively, it could be achieved by initial insertion of heavy and light chain variable regions into two separate mice and the subsequent breeding of the two mice, resulting in a mouse with both human heavy and light chain variable regions.

An aspect of this targeted insertion is, according to Regeneron, placement at a precise point: the human variable region gene segments must be adjacent to the mouse constant regions. Regeneron’s technical expert, Dr. Oettinger, refers to this as “functional” linkage. In addition, Regeneron asserts that a necessary part of this invention includes retention of mouse regulatory regions, specifically the transmembrane and cytoplasmic tail. Regeneron asserts that the commercial embodiment of the invention is its VelocImmune mouse. These aspects of the invention are important to the issues here before the Court. A differently defined invention runs directly into the prior art Merus claims Regeneron failed to disclose during patent prosecution.

⁵ The term “chimeric” comes from Greek mythology, in which the Chimera was a fire-breathing monster made up of parts from different animals: a lion’s body, topped with dual lion and goat heads, and ending in a serpent for a tail. In usage today the term typically refers to something comprising more than one animal. The term “reverse chimeric” here means having the mouse as the primary animal to which the human DNA is added; the animal is “chimeric” as it is composed of DNA from two animals, and “reverse chimeric” as it is composed primarily of non-human DNA to which human DNA has been added.

According to Merus, the invention (and claim 1 in particular) does not contain all of the limitations Regeneron now asserts. As an initial matter, it is not limited to mice with entirely human variable regions and entirely mouse constant regions, but may include those with combined human and mouse variable regions (that is, there is an insertion of human variable, but no deletion of the mouse, or insertion of human heavy chain leaving the mouse light chain, or vice versa). In addition, according to Merus, although claim 1 specifies that the insertion must occur into the Ig locus, it does not require insertion at the particular point within the locus (adjacent to, but neither overlapping with nor short of, the mouse constant region) as Regeneron now asserts; and this lack of specificity could lead to a mouse with an impaired immune response. Finally, according to Merus, the VelocImmune mouse, which Regeneron represented to the PTO was the commercial embodiment of the '018 Patent, did not exist in February 2001; Regeneron only succeeded in making it several years later, after a number of failed attempts – and then by a process different from that disclosed in the '018 Patent.

II. DESCRIPTION OF THE TECHNOLOGY IN THE PATENT

According to the specification of the '018 Patent, the method used to engineer this chimeric mouse involves “utilizing large DNA vectors to target, via homologous recombination, and modify, in any desirable fashion, endogenous genes and chromosomal loci in eukaryotic⁶ cells.” ('018 Patent, “Abstract.”) The large DNA

⁶ “Eukaryotic cells” are cells that have different compartments that serve distinct roles; for instance, chromosomes are housed within the cell nucleus. (Clynes Decl., ECF No. 105, p. 11, n. 2.) Eukaryotic

vectors used in this process are defined in the specification as “LTVECs” – that is, large targeting vectors for eukaryotic cells. LTVECs are “derived from fragments of cloned genomic DNA larger than those typically used by other approaches intended to perform homologous targeting in eukaryotic cells.” (Id., 9:39-42.) A “targeting vector” is “a DNA construct that contains sequences ‘homologous’ to endogenous chromosomal nucleic acid sequences flanking a desired genetic modification(s). The flanking homology sequences, referred to as the ‘homology arms’, direct the targeting vector to a specific chromosomal location within the genome. . .” (Id., 8:66-9:4.)

cells are the building blocks of humans, mice, and other higher order life; they are distinguished from bacteria which have no cellular compartments. (Id.)

All of the figures in the specification show versions of homologous recombination with LTVECs of various types and sizes, none smaller than 20 kilobases (“kb”). For instance, Figures 1 and 2 in the specification show a DNA “modification cassette” (or insert) being transferred by homologous recombination into a large targeting vector in a mouse’s genome:

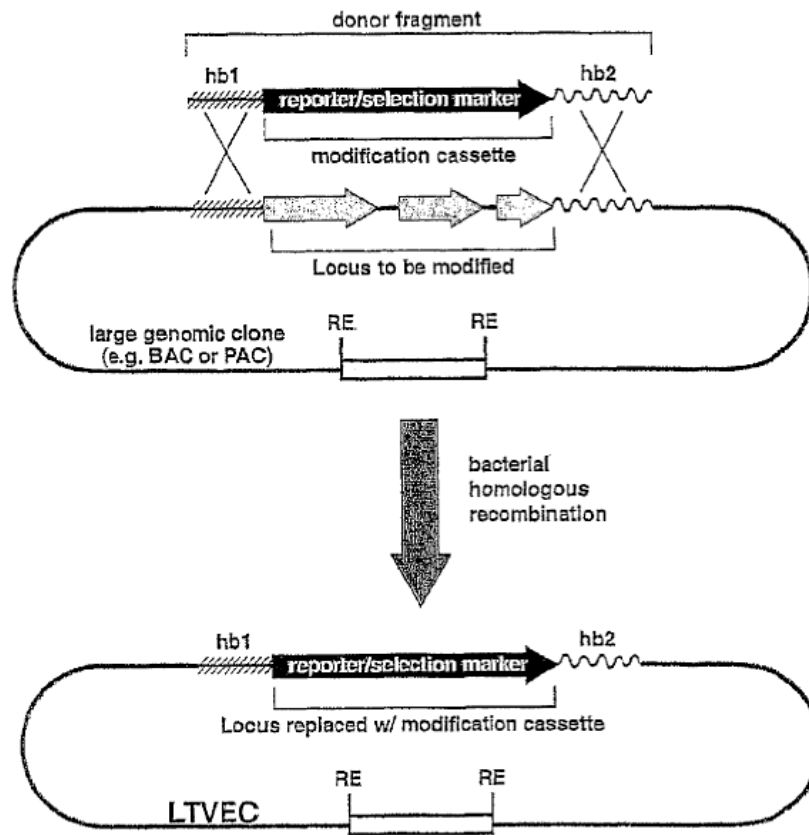

(Id., Fig. 1.)

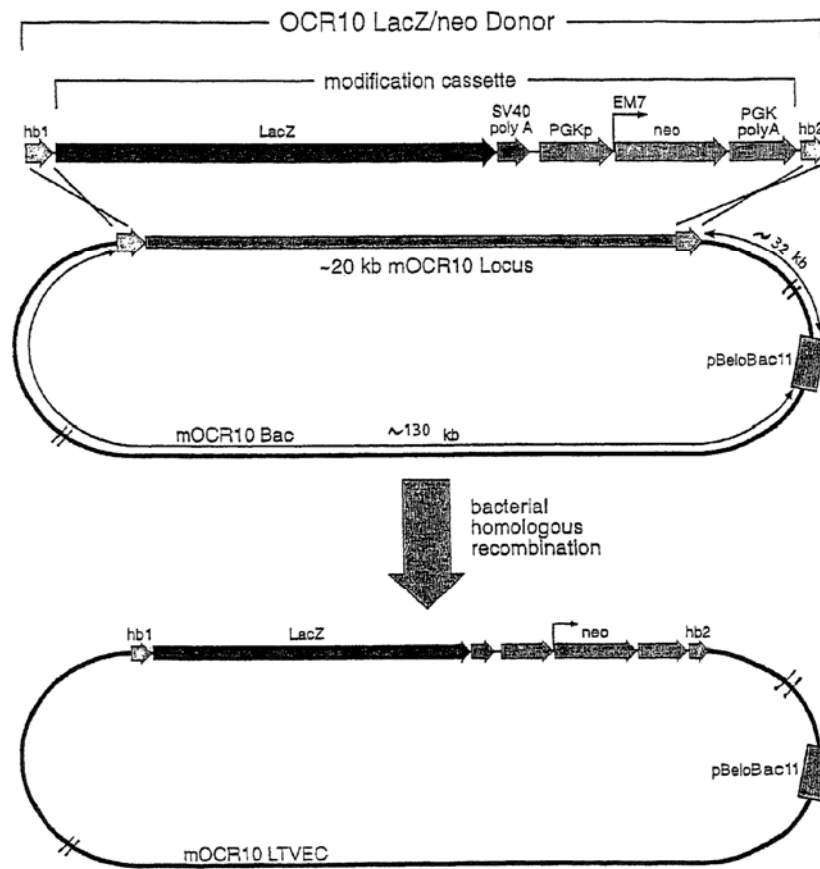

(Id., Fig. 2.)

Figures 4A-4D of the '018 Patent show a human insert in a LTVEC of 200-300 kbs:

Figure 4A Human Ig heavy chain locus (total length ≈1Mb, not drawn to scale):

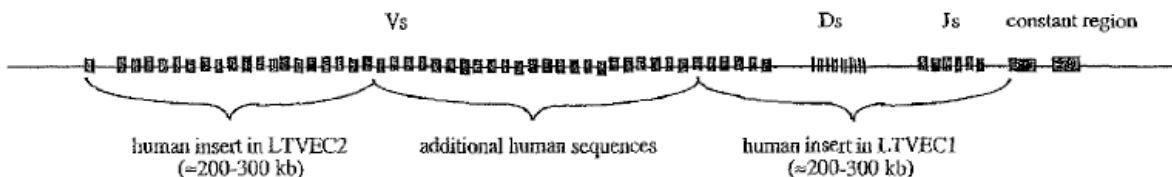

Figure 4B Mouse IG heavy chain locus (total length ≈1Mb, not drawn to scale):

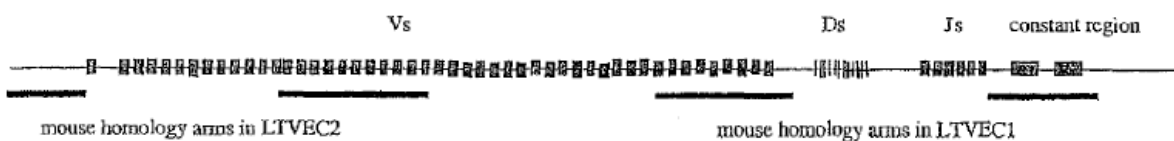

Figure 4C LTVEC2:

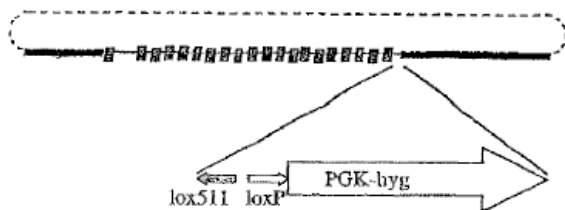
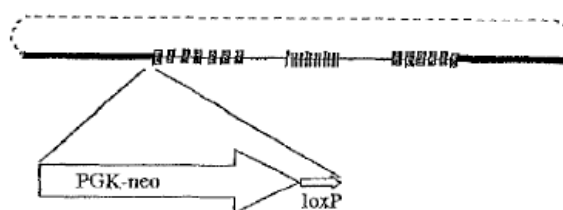

Figure 4D LTVEC1:



The specification states that “use of LTVECs provides substantial advantages over current methods” of homologous recombination. (*Id.*, 1:37-38.) “LTVECs can be more rapidly and conveniently generated from available libraries of large genomic DNA fragments (such as BAC and PAC libraries⁷) than targeting vectors made using current technologies.” (*Id.*, 1:40-43.) “The present invention” is described as providing for “a rapid, convenient, and streamlined method for

⁷ BAC and PAC are acronyms that respectively stand for “bacterial artificial chromosome” and “P1-derived artificial chromosome.”

systematically modifying virtually all the endogenous genes and chromosomal loci of a given organism.” (Id., 1:51-54.)

The specification also states that “[i]n accordance with the present invention, Applicants provide novel methods that enable the use of targeting vectors containing large regions of homology so as to modify endogenous genes or chromosomal loci in eukaryotic cells via homologous recombination. Such methods overcome the [limitations in the prior art.]” (Id., 2:64-3:2.)

In the “Summary of the Invention,” the specification states, “In accordance with the present invention, Applicants have developed a novel, rapid, streamlined, and efficient method for creating and screening eukaryotic cells which contain modified endogenous genes or chromosomal loci.” (Id., 3:11-14.) The method uses LTVECs, introduces them into eukaryotic cells to modify the endogenous chromosomal locus of interest, and analyzes the cell with an assay⁸ for modification of the allele⁹ (“MOA assay”). (Id., 3:15-25.) The ‘018 specification references thirty (30) preferred embodiments, including several which are far broader than the invention Regeneron now describes. For instance,

- “A preferred embodiment of the invention is a method for genetically modifying an endogenous gene or chromosomal locus in eukaryotic cells [using LTVECs].” (Id., 3:27-30.)
- “Yet another preferred embodiment is a genetically modified eukaryotic cell that is produced by the method of the invention.” (Id., 4:6-8.)

⁸ An assay is a quantitative or qualitative test of a substance.

⁹ An allele is one of two or more versions of a gene.

Certain embodiments make clear that deletions and insertions of genetic sequences are separate and distinct concepts, and that one is not assumed within the other (that is, an insertion of a genetic sequence does not necessarily imply a deletion of a sequence). For instance,

- “Another embodiment of the invention is a method wherein the genetic modification to the endogenous gene or chromosomal locus comprises deletion of a coding sequence, gene segment, or regulatory element; alteration of a coding sequence, gene segment, or regulatory element; [or] insertion of a new coding sequence, gene segment, or regulatory element . . .” (*Id.*, 3:40-43 (emphasis added).)
- “An alternative embodiment of the invention is a method wherein the alteration of a coding sequence, gene segment, or regulatory element comprises a substitution, addition, or fusion . . .” (*Id.*, 3:48-51 (emphasis added).)
- “Also preferred is a transgenic mouse having a genome comprising entirely human heavy and light chain variable region loci operably linked to entirely endogenous mouse constant region loci such that the mouse produces a serum containing an antibody . . . ; a transgenic mouse containing an endogenous variable region locus that has been replaced with an homologous or orthologous human variable locus, such mouse being produced by a method comprising [obtaining and using LTVECs].” (*Id.*, 7:24-38 (emphasis added).)

Other embodiments directly contradict Regeneron’s description in this proceeding of its invention as requiring a mouse with entirely human variable regions and entirely mouse constant regions. For instance,

- “One embodiment of the invention is a method of replacing, in whole or in part, in a non-human eukaryotic cell, an endogenous immunoglobulin variable region gene locus with an homologous or orthologous¹⁰ human gene locus comprising [using the LTVEC process to] introduce[e] the LTVEC ... into the eukaryotic cells to replace, in whole or in part, the endogenous immunoglobulin variable gene locus...” (Id., 5:44-60 (emphasis added).)
- “Another embodiment of the above method is a method wherein [certain steps] are repeated until the endogenous immunoglobulin variable region gene locus is replaced in whole with an homologous or orthologous human gene locus.” (Id., 6:11-15 (emphasis added).)
- “Another embodiment of the method is one in which the immunoglobulin variable gene locus is a locus selected from the group consisting of a) a variable gene locus of the kappa light chain; b) a variable gene locus of the lambda light chain; and c) a variable gene locus of the heavy chain.” (Id., 6:16-20 (emphasis added).)
- “Also preferred is an embryonic stem cell wherein the mouse heavy chain variable region locus is replaced, in whole or in part, with a human heavy chain variable gene locus; an embryonic stem cell wherein the mouse kappa light chain variable region locus is replaced, in whole or in part, with a human kappa light chain variable region locus; an embryonic stem cell wherein the mouse lambda light chain variable region locus is replaced, in whole or in part, with a human lambda light chain variable region locus; and an embryonic stem cell wherein the heavy and light chain variable region gene loci are replaced, in whole, with their human homologs or orthologs.” (Id., 7:6-18 (emphasis added).)

¹⁰ “Homologous” means “two or more nucleic acid sequences that are either identical or similar enough that they are able to hybridize to each other or undergo intermolecular exchange.” (’018 Patent, 9:9-11.) An “orthologous” sequence refers to “a sequence from one species that is the functional equivalent of that sequence in another species.” (Id., 9:51-53.)

- “Yet another preferred embodiment is an antibody comprising a human variable region encoded by the genetically modified variable gene locus of described above; an antibody further comprising a non-human constant region; and an antibody further comprising a human constant region.” (*Id.*, 7:19-23 (emphasis added).)
- “Also preferred is a transgenic mouse having a genome comprising entirely human heavy and light chain variable region loci operably linked to entirely endogenous mouse constant region loci such that the mouse produces a serum containing an antibody comprising a human variable region and a mouse constant region in response to antigenic stimulation; a transgenic mouse having a genome comprising human heavy and/or light chain variable region loci operably linked to endogenous mouse constant region loci such that the mouse produces a serum containing an antibody comprising a human variable region and a mouse constant region in response to antigenic stimulation...” (*Id.*, 7:24-35 (emphasis added; note inclusion of the word “entirely” in the first example and the absence of that word in the second).)

Notably, the preferred embodiments are consistent with Merus’s description of the invention and, as described below, the broadest reasonable construction of the claims.

A. Certain Technical Principals Relevant to this Opinion¹¹

Technical experts retained by Regeneron and Merus testified at the trial: Marjorie A. Oettinger, Ph.D. for Regeneron and Geoff Davis, Ph.D., for Merus. Both have substantial expertise in their fields. The Court relies upon both in its findings with regard to various basic technical principles relevant to the issues before the

¹¹ The Court set forth a similar section on Technical Principles in its Markman decision. (ECF No. 210.) This section has been modified to reflect trial testimony and documents received into evidence in this proceeding. Notably, Merus’s expert, Geoff Davis, Ph.D., proceeded in a similar manner in his Trial Declaration by incorporating by reference the background technical information the Court had previously received in connection with claim construction. (See Davis Tr. Decl. ¶ 16.)

Court.¹² Where one differed from the other in a material way, several examples of which are described in this Opinion, the Court found Dr. Davis more persuasive and his opinions based on a more substantial foundation. All technical determinations included in this Opinion constitute findings of fact.

The technology relating to the '018 Patent generally involves a method to genetically modify mice to contain large fragments of human genomic DNA by use of targeting vectors (described below) and assay. The goal is to produce antibodies useful in drug discovery and, eventually, production of potentially useful therapeutic antibodies. (Davis Tr. Decl.¹³ ¶ 17.) DNA is a molecule in a cell which carries the genetic material for living organisms and is capable of self-replication and synthesis. It consists of a double-stranded molecule that pairs in a double-helical structure: "One end of each strand is called the 5-prime (5') end, and the other is called the 3 prime (3') end." The 5-prime and 3-prime ends define the boundaries of a strand of DNA. One of the issues before the Court – and which was also at issue during claim construction – is whether the metes and bounds of the 5' end of the immunoglobulin locus was sufficiently understood as of the relevant date, February 16, 2001. The concern is whether practicing the invention required defining the 5' end of the locus, which is the beginning of the variable region. Merus asserts that without such definition, targeted insertion of a human variable region gene segment could miss the locus altogether, or it could fall short of

¹² See Trial Aff. of Dr. Marjorie A. Oettinger (ECF No. 345) and Trial Decl. of Dr. Geoff Davis. (ECF No. 338); see also Trial Tran. 650:4-916:12 (Oettinger testimony) and Trial Tran. 117:3-473:4 (Davis testimony).

¹³ Dr. Davis's trial declaration was filed under seal. (See ECF No. 338.)

insertion at a point that would reliably produce a useful antibody. Regeneron, in contrast, asserts that while the precise metes and bounds of the 5' end were not known in 2001, enough was known as to the size of the loci to allow for practice of the invention. As discussed below, the Court is persuaded by Merus's expert Dr. Davis on this point and disagrees with Regeneron.

DNA molecules are made up of chemical building blocks called "nucleotides". Nucleotides on the two strands of the double-helix pair with one another in complementary units called "base pairs." The base pairings connect the individual DNA strands to one another to form the double-helix. The unique sequence of bases on a given strand represents a code; a gene is a unit of DNA that includes the sequence of bases representing the codes for the amino acids that comprise a particular protein. In this case, the concept of kilobase pairs has some relevance. The term "kilobase pairs" refers to a DNA strand 1,000 base pairs long. In the '018 Patent, a core aspect of the invention is the utilization of a large fragment of DNA – measured in kilobase pairs – for targeted insertions.¹⁴

Genes are expressed by cells as proteins through processes commonly referred to as "transcription" and "translation". Before transcription and translation, the two strands of DNA that constitute a gene unwind from their double-helix configuration. During transcription, machinery in the cells reads the DNA sequence of one of the DNA strands, nucleotide by nucleotide, and uses it as a

¹⁴ During claim construction, one issue was whether, as of February 2001, Regeneron was actually able to successfully insert a DNA fragment of such length.

template to produce an intermediate molecule called messenger RNA (abbreviated as mRNA). The structure of a protein gives rise to its biologic activity.

A key benefit of the invention as described in the '018 Patent is successful B cell replication. "B cells" make antibodies. Antibodies are also known as "immunoglobulins." They are a particular type of protein with the potential to bind specifically to foreign antigens. (Oettinger Trial Aff.¹⁵ ¶ 22.) All immunoglobulins have a similar structure. (Id. ¶ 23.) They are typically depicted as having a structure shaped like the letter "Y". (See id. Fig. 1.) The Y structure consists of four chains of amino acids: two identical light chains and two identical heavy chains. Each light chain pairs with a partner heavy chain, and then each heavy-light chain pair associates with an identical heavy-light chain pair to form the "Y" structure. See Figure 1¹⁶ below:

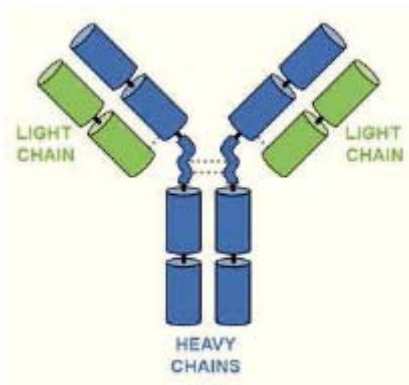

Each Ig heavy or light chain is composed of several regions. (Oettinger Trial Aff. ¶ 24.) Within an immunoglobulin subunit, there are regions with extensive amino acid sequence variations between them, which are called "variable" regions.

¹⁵ Dr. Oettinger's trial affidavit was filed under seal. (See ECF No. 345.)

¹⁶ Figures in this opinion without a specifically identified source are not found in the '018 Patent.

(Id.) Regions that show no sequence variation within a species are called “constant” regions. (Id.) Each heavy chain and light chain is comprised of a “constant” region and a “variable” region. In both heavy chains and light chains of an antibody, the region at the tip of the “Y” is the variable region. The other region on each heavy chain and light chain is the constant region. See Figure 2:

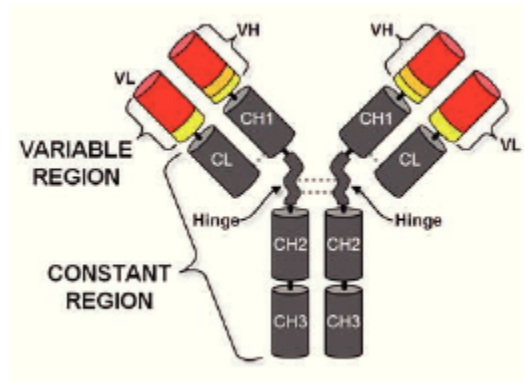

The heavy chains are referred to by the letters of the Greek alphabet. The heavy chains of the different classes of immunoglobulins, IgM, IgD, IgG, IgA and IgE, are referred to as μ (mu), δ (delta), γ (gamma), α (alpha) and ϵ (epsilon), respectively. (Id. ¶ 27.) Oettinger states that “a comparison of the constant regions between different species ... reveals important differences. For example, although the amino acid sequences of the constant regions of mouse and human IgG1 have about 70% sequence identity, there are numerous amino acid substitutions that distinguish one from the other. These species-species features are important when considering the functional and antigenic properties of human immunoglobulins introduced into a different species...” (Id.)

Important to the issues before this Court is the fact that, as Dr. Oettinger testified and as further set forth in Dr. Davis’s Trial Declaration (See Davis Tr.

Decl. ¶ 322), replacement of an entire variable region requires at least two steps: replacement of the heavy chain of the variable region, and replacement of the light chain. (ECF No. 398, 674:2-19.) Insertion of an entire exogenous variable region requires two similar insertion steps – one for the heavy chain and one for the light. It would not matter which order such replacement or insertion was accomplished – but it cannot be accomplished in a single step. (Id., 674:20-675:2.)

Antibodies are proteins composed of amino acids, encoded by genes composed of DNA nucleotides. The DNA that encodes antibody variable regions is assembled from separate gene “segments.” A gene that encodes the heavy chain variable region of an antibody is assembled from three gene segments, named the variable (V or V_H), diversity (D or D_H) and joining (J or J_H) segments (the subscript “H” indicates the gene segment that forms part of the antibody heavy chain). A gene that encodes the light chain variable region of an antibody is assembled from two gene segments, named the variable (V or V_L) and joining (J or J_L) segments (the subscript “L” similarly indicates the light chain). These gene segments are joined together to form contiguous variable region gene segments (V(D)J for heavy chains, and VJ for light chains) through DNA rearrangement mechanisms. (Oettinger Tr. Aff. ¶ 35.) The genetic structure of the immunoglobulin loci together with the capacity of immunoglobulin DNA to (1) rearrange, (2) switch, and (3) further mutate, allows for the production and development of a diverse antibody repertoire; these activities may also be referred to generally as recombination, isotype switching, and hypermutation. (Davis Tr. Decl. ¶ 22.)

In order to generate mice that produce humanized antibodies, the '018 Patent sets out a method of integrating human genomic immunoglobulin DNA into the mouse genome. (Id. ¶ 23.) In both humans and mice there is one gene locus containing the genetic material used for expressing heavy chains, and two gene loci containing genetic material used for expressing light chains. Through a process known as V(D)J recombination, the DNA sequence encoding a variable region of an antibody heavy or light chain is created at each Ig gene locus by selecting and joining together one each of the many V, D and J gene segments (for heavy chains) or V and J gene segments (for light chains) present at the locus. (Oettinger Tr. Aff. ¶ 41.) V(D)J recombination is referred to as “somatic recombination”. See Figure 3:

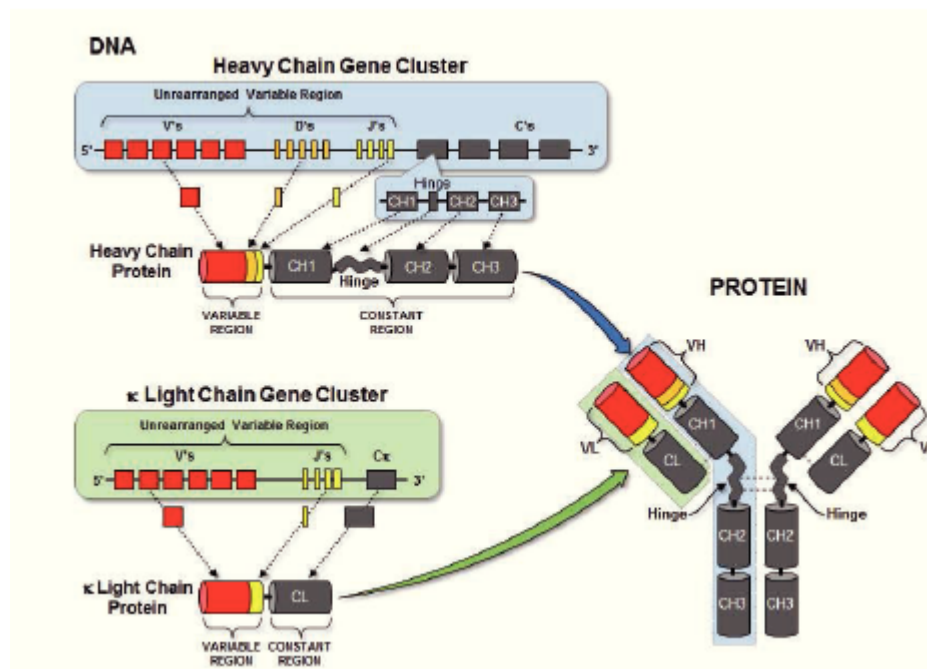

V(D)J recombination (i.e., somatic recombination) is part of the process of B cell development essential to encode a complete antibody. All antibodies made by

one B cell are identical. (Id. ¶ 29.) Thus, in order to have a diversity of antibodies, a diversity of B cells is required. B cell rearrangement is essential to that process. Somatic mutations (i.e., changes in DNA sequences in B cells as opposed to germline cells) then further act to increase the affinity of an antibody with a given specificity. (Id.) “B cells arise in the bone marrow, where lymphoid progenitor cells develop into ‘immature’ B cells.” (Id. ¶ 30.) During this developmental process, rearrangements take place in the immunoglobulin genes. This is the “V(D)J recombination” discussed above. (Id.) If a successful gene rearrangement takes place, the B cell eventually acquires the capacity to display a “B cell receptor” on its surface; this B cell receptor is a “membrane-bound version of an immunoglobulin.” (Id.)

Successful rearrangement of the heavy chain locus allows the B cell to produce a membrane-bound μ (mu) chain. (Id. ¶ 43.) In early B cell development, the membrane-bound μ (mu) chain is the first functional Ig subunit that is expressed: at this time, the light chain genes have not yet rearranged and the B cell does not make the complete B cell receptor, so the B cell is not capable of specific antigen recognition. (Id.) At this stage, only a membrane-bound μ (mu) heavy chain is expressed and the cell that carries it is referred to as a “pre-B cell.” (Id.) The membrane-bound μ (mu) chain is anchored in the membrane of the pre-B cell with the bulk of its mass facing outward. (Id. ¶ 44.) The membrane-bound μ (mu) chain forms a complex with two so-called “surrogate” light chains and two

“accessory proteins;” this complex is referred to as the pre-B cell receptor (“pre-BCR”). (Id. ¶ 45.)

The μ (mu) region, which has both a transmembrane domain and a cytoplasmic tail, plays an important role in this proceeding. Regeneron asserts that a benefit of the invention in the ‘018 Patent is retention of a mouse μ (mu) region when human (heavy and light chain) variable regions have been inserted. Merus argues – and Davis persuasively supports this argument – that nothing in claims 1-5 requires retention of the murine μ (mu) region.

There are – and at the time of the invention in February 2001 there already were – numerous methods for incorporating exogenous DNA, such as human DNA, into mice. The first method was the insertion of a “transgene” by random integration. A “transgene” is a DNA sequence originating from outside the host organism. One may create a “transgenic mouse” by injecting an exogenous DNA fragment into a fertilized mouse egg. (See ECF No. 400, 850:10-20; Davis Tr. Decl. ¶¶ 19, 59.) The DNA fragment is then incorporated into a random chromosomal location in the genome of the embryo. The exact location where the transgene DNA ends up in the genome is random. This process is known as “random integration”. Random integration may result in the location of the added DNA in an area which is more or less transcriptionally active and can also disrupt or render nonfunctional DNA regions into which it integrates. In other words, the inserted DNA may or may not be where you want it to be in the mouse genome.

Non-randomized methods of genetic modification also existed prior to February 2001. The methods are sometimes generally referred to as “gene targeting.” (Davis Tr. Decl. ¶ 19.) The key technique used for targeted gene modification that had been developed before 2001 is called “homologous recombination.” (See, e.g., id. ¶¶ 18-20.) Homologous recombination relies on a vector (one can think of this as a “chunk”) comprised of the foreign DNA that one seeks to insert, flanked by regions of DNA that are homologous to the desired integration site, known as the homology arms. (Id. ¶ 19.) To facilitate homologous recombination, the DNA sequence of interest is flanked by “homology arms;” these arms consist of DNA fragments that are substantially the same in sequence as the sequences that flank the target DNA sequence being replaced or augmented in the genome. These arms allow the targeting construct to align with the host genome to ensure modification at the desired position. Targeted insertion directs the DNA from the vector to integrate at a particular site (or location) without changing the nearby regions of the host genome (this is an “insertion”), or it can direct the foreign DNA to replace a portion of the host genome with the foreign DNA to be integrated (“replacement” or “substitution”); this may include a deletion step. (Id.)

An example of targeted insertion – without deletion – is shown below in Figure 4 as integrated DNA without removing the DNA of the targeted genome:

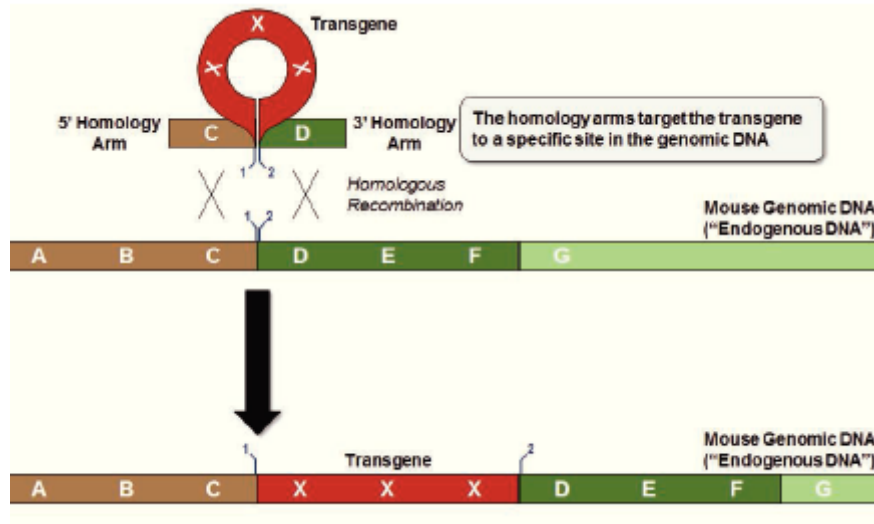

Insertion without deletion differs from “replacement” or “substitution” of mouse DNA with homologous human DNA. Implicit in replacement or substitution is the concept of removal, or possibly other inactivation, of the original gene segment. In this way, the mouse DNA would not be present (or active) in the mouse cell and the human DNA would be. (Davis Tr. Decl. ¶ 19.)

The ‘018 Specification teaches a method of homologous recombination between a mouse and human in which the specific target is the immunoglobulin locus. In the ‘018 Patent, the mouse is the host, and a portion of an homologous human gene segment (here, some or all of the variable region) is inserted into the mouse’s immunoglobulin locus. To do this, a “targeting vector” must be created. As described above, a “vector” is a vehicle which holds the DNA sequence (or gene segment) that the scientist intends to be incorporated into the mouse genome. To

facilitate homologous recombination, the DNA sequence of interest is flanked by “homology arms”; these, again, are DNA fragments that are substantially the same in sequence as the sequences that flank (or are at either end) of the target DNA sequence being replaced or augmented in the genome. These arms allow the targeting construct to align with the host genome to ensure modification at the desired position. Put otherwise, to drop the gene sequence into a particular locus you need a beginning and end that matches the beginning and end of the same sequence in the host; and to review (because this is complicated stuff) the entire segment is called the vector and the beginning and ends are the “arms” or “homology arms” of that vector.

When the amino acid sequence of a protein is represented in a linear fashion, it is represented by convention with the “amino-terminal” end on the left and the “carboxyl-terminal” end on the right. (Oettinger Trial Aff. ¶ 28.) For nucleic acids such as DNA, the “upstream” or “5” (“five-prime”) portion is shown on the left and the “downstream” or “3” (“three-prime”) portion is shown on the right, with the encoding sequence in the middle. (Id.)

One can think of this as a section of rope with a knot on one end signifying the 5’ end of the locus, the middle section as a gene segment, and a knot on the far end as the 3’ end of the locus. Thus, the immunoglobulin loci have a 5’ end and a 3’ end; in between are the heavy and light chain variable region gene segments and the heavy and light chain constant region segments, with the variable segments arranged at the 5’ end and the constant segments toward the 3’ end. One can think

of the 5' and 3' ends as the boundary lines of the locus. Outside of the 5' and 3' one is outside of the locus; inside the boundary lines are all of the various regions including the variable regions (heavy and light) and constant regions (heavy and light). Thus, knowing the 5' and 3' defines the playing field – but where on the playing field one desires to place the “ball” (or gene segment), if one desires a specific location, requires additional information.

Continuing with our playing field analogy, to place the ball at the 50 yard line, one needs to know where that is. Of course, one also needs to know whether the coach cares where on the field the ball is placed, or whether the intent is just to get it onto the field. The “coach” (scientist) may be indifferent. This concept is important for the invention at issue in the '018 Patent – both because Merus claims that the metes and bounds of the 5' was unknown in February 2001, and because Regeneron now claims that the location within the locus (in our analogy, the precise point on the playing field) at which the targeting needs to occur, is quite specific. As discussed below, Regeneron asserts (through Dr. Oettinger) that the insertion of the human DNA segment must occur distal to, and upstream of, the 5' such that it is next to, but not within, the area which contains the mouse constant regions.

Thus, performing targeted insertion of variable gene segments into the immunoglobulin locus of a mouse requires choosing a homology arm upstream (5') of the chromosomal fragment, and a homology arm downstream (3') of that fragment. If homologous recombination occurs within the boundaries established by the

homology arms, the insertion has been accomplished. Figure 4 is worth repeating here to illustrate this:

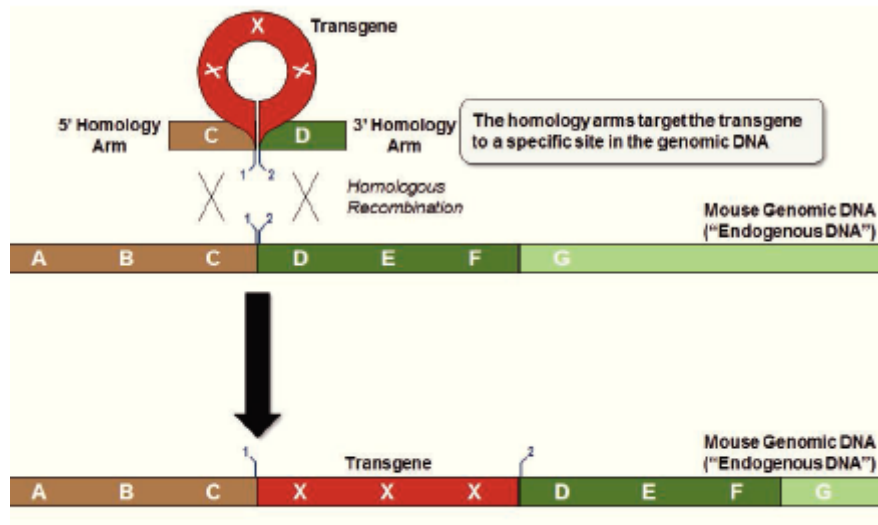

Notice that in the figure above, depicting an example of insertion, the transgene (that is, the gene from the outside human organism) has been added into, but has not replaced, the existing genes in the mouse. As discussed, a separate process would be required to delete the pre-existing homologous segment, or to inactivate it.

Over time, scientists skilled in the art have found that human gene segments inserted into a mouse genome, and into the immunoglobulin gene in particular, are able to rearrange and thereby produce a broad spectrum of VDJ and VJ regions (for heavy and light chains) that are expressed in antibodies.

The method set forth in the '018 Patent may result in genetically modified mice that can produce antibodies useful in drug discovery and downstream production of potentially useful therapeutic antibodies. (Davis Tr. Decl. ¶ 17.) As discussed below, that same method may also, however, produce a mouse capable of

producing inferior or even useless antibodies.¹⁷ This might occur if (1) the insertion occurs in the gene (e.g. somewhere on the playing field) at a point that is not next to the constant region – perhaps even within the constant region; (2) the inserted human gene segment is only one portion of the variable region (e.g. heavy but not light chain or vice versa), or (3) the homologous mouse gene segment is not deleted or inactivated, but instead continues to exist within the locus.

It should be clear by this point that Drs. Oettinger and Davis do not agree on various technical aspects of the invention. Indeed, they disagree on certain fundamental points. In making its determinations herein, the Court has read the material submitted by each and had the opportunity to see them on cross-examination and redirect, and also to pose certain questions itself. While the Court does find Dr. Oettinger experienced in the relevant area, the Court credits Dr. Davis's views on technical aspects in which they differ, including on the invention. That is due to the reasoned basis for Dr. Davis's views, the evidence he brought to bear to support his views, and how he responded on cross examination. As stated above, the Court's technical statements are, therefore, findings of fact.

Among their disagreements is whether insertion of the human V-D-J/V-J (that is, both heavy and light chain variable regions) and deletion of the homologous mouse sequences leaves intact all of the sequences, including regulatory sequences, necessary to enable the production of useful antibodies. Dr. Oettinger asserts that it does, and Dr. Davis disagrees. Dr. Davis testified credibly that “[t]here are ...

¹⁷ As Dr. Davis notes, creation of an antibody is not a requirement of claims 1-5 of the '018 Patent. (Davis Tr. Decl. ¶ 44.)

important differences between the loci in organization, regulation and existence of embedded genes associated with other functions in the organism, which do not comport with the assertion” that all necessary sequences for proper transcription, recombination and/or class switching are left intact. (*Id.* ¶ 27.) One example highlights the importance of this disagreement.

Following its submission of the ‘018 Patent Application, Regeneron learned that embedded in the mouse heavy chain Ig locus there are genes (referred to as ADAM6) that are important for mouse fertility. If those genes are deleted according to the instructions set forth in the ‘018 Patent (and as referenced in Figures 4A-D of the ‘018 Patent), the resulting mouse will be infertile or have impaired fertility. (*Id.* ¶ 28; DX 159, at 734, 737; see also DX 3, U.S. Patent No. 8,642,835 at 1:15-28.)

ADAM6 genes found in mouse and human IgH loci

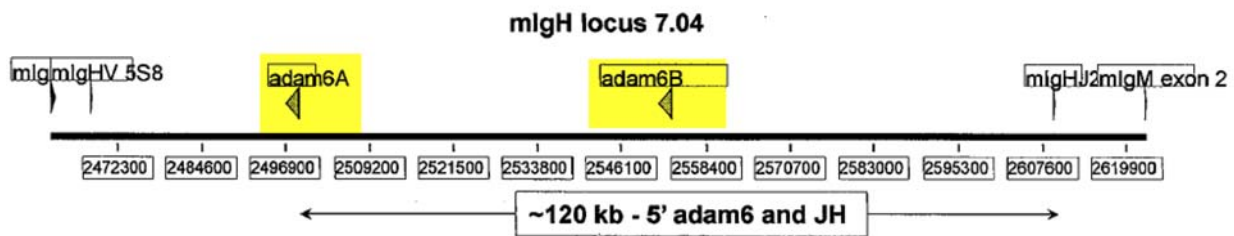

FIELD OF INVENTION

Genetically modified mice, cells, embryos, and tissues that 15
 comprise a nucleic acid sequence encoding a functional
 ADAM6 locus are described. Modifications include human
 and/or humanized immunoglobulin loci. Mice that lack a
 functional endogenous ADAM6 gene but that comprise
 ADAM6 function are described, including mice that com- 20
 prise an ectopic nucleic acid sequence that encodes an
 ADAM6 protein. Genetically modified male mice that com-
 prise a modification of an endogenous immunoglobulin V_H
 locus that renders the mouse incapable of making a functional
 ADAM6 protein and results in a loss in fertility, and that 25
 further comprise ADAM6 function in the male mice are
 described, including mice that comprise an ectopic nucleic
 acid sequence that restores fertility to the male mouse.

Another point of difference concerns the identity of light and heavy chains. For instance, Dr. Davis takes issue with Dr. Oettinger's assertion that a naturally occurring Ig molecule always has two identical light chains and two identical heavy chains. Dr. Davis states, with support, that (for example) the IgG4 is "inherently unstable" and "exchange of HL pairs may occur resulting in different heavy chains and/or light chains in the circulation." (Davis Tr. Decl. ¶ 25.) He further states, with support, that while Dr. Oettinger asserts that the unrearranged variable region gene structures of heavy and light chains are similar, they are not always so. (Id. ¶ 27.) For instance, mouse heavy and light chain Ig loci organization and content are different. "[T]he mouse endogenous lambda locus has regulatory elements, and constant regions sandwiched between V and J gene segments." (Id. ¶ 29.)

Mouse and human Igλ loci differ significantly in size, diversity and usage

mouse IgL locus 3Vλ (~200 kb)

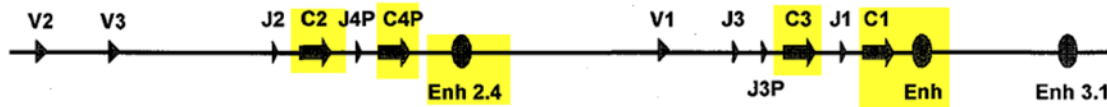

According to Dr. Davis, and the Court credits his testimony in this regard, if one skilled in the art were to follow the targeting strategy set forth in the '018 Patent for the lambda locus, he or she would be removing mouse constant regions and regulatory elements within that locus. (*Id.* ¶ 30.) This conflicts with Dr. Oettinger's assertion that the invention requires maintaining the totality of the mouse constant region intact. (*Id.* ¶ 31.)¹⁸

III. PROSECUTION HISTORY OF THE '018 PATENT

U.S. Patent Application No. 13/164,176 (the '176 Application), entitled "Method of Modifying Eukaryotic Cells," was filed on June 20, 2011. (*See* '018 Patent.) The application issued as U.S. Patent No. 8,502,018 (the '018 Patent) on August 6, 2013, to inventors Drs. Andrew J. Murphy and George D. Yancopoulos, (*Id.*) and was assigned to Regeneron.

¹⁸ One of the more curious moments in the trial was when Dr. Oettinger testified that she had been instructed not to talk to the inventor – Dr. Andrew J. Murphy – about the '018 Patent. While lawyers understandably try to prevent or limit interactions among trial witnesses to avoid claims that testimony is coordinated, that ought to be balanced against providing an expert with access to an important source of information as to how the invention developed and the intended scope of the claims, etc., namely the inventor himself.

As originally filed, claim 1 of the '176 Application describes "A genetically modified mouse, comprising in its germline human unrearranged variable gene region segments inserted at a mouse immunoglobulin locus." (DX 2 at 44.) But for the later inclusion of the word "endogenous", this is identical to claim 1 of the '018 Patent as issued.

On January 26, 2012, the PTO issued a Non-Final Office Action rejecting claims 1-19 of the '176 Application as being anticipated by a Lonberg reference, 2006/0015957 (Id. at 128-39.) That Office Action stated, in part:

Lonberg and Kay teach heterologous unrearranged immunoglobulin human heavy and light chain transgenes useful for producing transgenic mice...and transgenes are typically integrated into host chromosomal DNA, into germline DNA.

...

Lonberg and Kay teach the production of chimeric human variable region/mouse constant region antibodies through trans-switching...thus the mouse does not comprise a human immunoglobulin constant region gene. (Id. at 131-32.)

On July 26, 2012, Regeneron's Dr. Tor Smeland, in-house counsel responsible for prosecuting that application and others in the same family in the United States and Europe, replied to this Office Action. He argued, inter alia, that unlike the '176 Application, Lonberg teaches random and not targeted insertion:

Lonberg does not disclose a mouse comprising in its germline human unrearranged variable region gene segments inserted at a mouse immunoglobulin locus. Instead, Lonberg discloses transgenes that are apparently randomly inserted at (unknown) loci. Lonberg simply lacks description of the claimed chimeric locus of claim 1. Amended claim 11 and amended claim 20 also recite a chimeric endogenous locus, which is not disclosed in Lonberg. Thus, regardless of whether Lonberg disclosed chimeric human variable/mouse constant antibody proteins,

Lonberg does not anticipate the claims because a disclosure of trans-switching does not disclose ... endogenous mouse loci that are modified as claimed...

...

The claimed method does not represent a selection from predictable solutions, i.e., the claimed method was not “obvious to try” at the time it was filed. An obvious to try argument assumes a design need or market pressure to solve a recognized problem in order to achieve an anticipated success. The art never recognized (1) that there was a “problem” to be solved in making antibodies from an endogenous mouse locus, or (2) that there was a design need or market pressure to achieve success at modifying an endogenous mouse immunoglobulin locus to make a chimeric endogenous locus. (*Id.* at 160-61, 163 (emphasis added).)

On October 11, 2012, the PTO mailed a Final Office Action, rejecting the pending claims of the ‘176 Application. The Final Office Action maintained the rejection of claims 1-19 as anticipated by Lonberg. (*Id.* at 180.)

In a January 11, 2013 Reply to the Final Office Action, Regeneron amended claim 1 to include the additional limitation that the human unrearranged variable region gene segments would be inserted at “an endogenous” mouse immunoglobulin locus. (*Id.* at 202.) In connection with that amendment Regeneron stated:

The Lonberg paragraphs cited by the Examiner merely disclose that human transgenes for making human antibodies were mentioned in the art. None of the cited paragraphs suggest or even hint at placing unrearranged human immunoglobulin gene segments at an endogenous mouse locus, much less a functional endogenous mouse locus. The cited portions of Lonberg leave no doubt whatsoever that the Lonberg mouse construction instructions were to build a transgenic mouse that makes fully human antibodies from transgenes that are distant from endogenous mouse immunoglobulin loci; i.e., they are synthetic loci randomly inserted into the mouse genome at a locus distant from any functional mouse immunoglobulin locus. Indeed, as is described in detail elsewhere in Lonberg, the Lonberg transgenic mouse requires that endogenous mouse immunoglobulin loci (both heavy and light chain loci) must be rendered non-functional so as to

allow the fully human immunoglobulin transgenes to make fully human antibodies. There is absolutely no hint or suggestion in Lonberg to employ a functional endogenous mouse locus having inserted unrearranged human immunoglobulin variable region gene segments in the functional locus. (Id. at 204-05.)

The reply also represented that the VelocImmune mouse is the commercial embodiment of the invention:

However, regardless of whether the Examiner has made a prima facie case of obviousness with respect to claim 20, Applicants submit that claim 20 is patentable because the claimed mouse exhibits features entirely unexpected in lights of the teachings of prior art (e.g., Lonberg, Brüggemann, Kawasaki, and Popov). The features of mice having disabled endogenous immunoglobulin loci and comprise transgenes that make antibodies with human variable domains have been disclosed in peer-reviewed publications disclosed in the information disclosure statement filed in this application, dated 20 September 2011. **The claimed mice, an embodiment of which is known in the art as a VELOCIMMUNE humanized mouse,** perform surprisingly and unexpectedly better than mice with disabled endogenous loci that express antibodies from randomly inserted transgenes (as in all of the references cited by the Examiner). (Id. at 209 (emphasis added).)

Attached to Regeneron's reply was a slide presentation (id. at 214-32) that Dr. Smeland provided to the PTO, and which he and Brendan Jones, an outside patent attorney retained to represent Regeneron in the final stages of prosecution of the Patent, relied on in a meeting with the PTO. (See id. at 290.) That presentation contains information which Merus asserts is false and was known to be false at the time. It concerns the VelocImmune mouse to which Dr. Smeland's January 2013 reply referred.¹⁹ Various figures in that presentation describe ways

¹⁹ This presentation forms the basis of Merus's "egregious misconduct" claim. In this portion of the Opinion the Court reviews that presentation in connection with its role in the chronology of later prosecutions. The Court returns to the presentation again later in this Opinion when discussing the "egregious misconduct" claim in particular.

in which the VelocImmune mouse was made. These figures are consistent with the presentation's assertion that the VelocImmune mouse was "Created only by virtue of VelociGene & VelociMouse technologies." (Id. at 215.)

As discussed more fully below, this Court agrees with Merus that these slides provide certain misleading and inaccurate information. First, as of February 2001, the VelocImmune mouse did not exist – Regeneron had been unable to make it. (See, e.g., DX 145²⁰; REGN-AM-10055694.) Yet the presentation suggests it did. In addition, on slide 10, a figure depicts the locus construction for the VelocImmune mouse. It indicates that Regeneron replaced a 3 mb segment with a 150 kb segment in a single step; that is, that both insertion and deletion occurred simultaneously. (DX 2 at 224.) This was not in fact the process used to produce the VelocImmune mouse. (Davis Tr. Decl. ¶ 279.) As discussed above, to insert both human heavy and light chain variable regions requires two steps (or a breeding step), and a third step is required to delete or inactivate the homologous mouse sequence in order to obtain therapeutically useful antibodies.

Moreover, in February 2001 (and for a substantial number of years thereafter), Regeneron had not succeeded in inserting and deleting a portion of mouse IgH DNA that was over 200 kb. (See, e.g., DX 145; REGN-AM-10055694.) Nevertheless, the '018 Patent depicts this in Figure 4 and the presentation indicates that insertion and deletion on this scale had occurred. Figure 4 of the '018 Patent

²⁰ Regeneron has argued that references to the contents of this exhibit should be redacted from this Decision. The Court disagrees. The contents of DX 145 were thoroughly discussed in open court during the trial and in Dr. Davis's Trial Declaration. The Court considers the contents of this exhibit relevant to this Decision and thus includes them without redaction.

shows a replacement of approximately 200-300 kb of human immunoglobulin DNA for mouse immunoglobulin DNA. ('018 Patent at Fig. 4).

In addition, the presentation discusses the ability of the VelocImmune mouse to preserve the transmembrane and cytoplasmic DNA of the endogenous mouse immunoglobulin locus as among its benefits over prior art mice. (DX 2 at 219, 222.) The presentation discusses the preservation of these regions as the "VelocImmune Hypothesis." (Id. at 226.) But neither the claims nor the specification contains such a limitation. (See '018 Patent, 3:27-8:3, 29:24-30:64.) Moreover, this concept was not novel. One of the references Regeneron had not disclosed to the PTO (and at issue in this proceeding), Zou, in 1994 disclosed the preservation of mouse constant cytoplasmic and transmembrane domains and stated that the mice produced humanized antibodies "at the same level and efficiency as wild-type mice produce murine IgG1 antibodies." (DX 72, Zou, et al. (1994) at 1099.) These undisclosed results undercut the claims of the VelocImmune mouse's superiority found in Dr. Smeland's January 2013 presentation, which extolled "Normal variable region usage and junctional diversity," as well as "Normal numbers and distribution of B cells in spleen and lymph node" and "Normal B cell differentiation in bone marrow." (DX 2 at 227; Davis Tr. Decl. ¶ 349.)

Dr. Andrew Murphy of Regeneron was one of the authors (but not presenters) of the slides that were provided to the PTO during patent prosecution. Prior to creating the January 2013 slide deck, Dr. Murphy had been told by another pioneering scientist in the field who had been on Regeneron's Scientific Advisory

Board, Dr. Frederick W. Alt, that assertions that VelocImmune mice demonstrated no major defects in B cell differentiation “could be a little misleading.” (DX 223 at 10039849; DX 111 REGN-AM-00061940) Dr. Alt shared this comment in an August 15, 2011 message that provided comments on a manuscript Dr. Murphy had sent Dr. Alt and others the prior March. In the March email, which was titled “VelocImmune manuscripts,” Dr. Murphy had told the recipients they were “listed as a co-author in one or both of the enclosed manuscripts,” and asked for any edits. (DX 112.)

In his comments on August 15, 2011, Dr. Alt responded to an assertion in the manuscript that read “No major defects were observed in B cell differentiation in any of the VelocImmune mice. The introduction of human IgH variable segments does not appear to affect either the pro B to pre-B transition nor do human IgK variables affect the proB to B transition.” (DX 223 at 10039848.) Dr. Alt wrote that, in his view, this statement was “correct but perhaps could be a little misleading.” (Id. at 10039849.) He explained that

when we looked at bone marrow BM there was a profound block in the pro-B and pre-B transition, suggesting that there is significant selection/expansion of the 3 human VH locus to get a normal percentage of B cells in the periphery.... [I]n reality if you have too few human VH then you may have impaired development and therefore the number of VHs is important, but once you have a certain number of VH genes (for example 18 in Velcoimmune), there is no obvious developmental impairment.” (Id.)

Another recipient of that same email, Dr. Klaus Rajewsky, also provided comments to Dr. Murphy. He advised Dr. Murphy that “[s]ince the first paper deals in depth with the issue of replacing mouse by human immunoglobulin gene

segments, it may be appropriate to quote the first paper(s) demonstrating such replacements, which were actually done in my lab almost 20 years ago. The references are attached.” (DX 113.) One of the attached references was the Zou reference that is alleged to be one of the Withheld References in this proceeding.²¹

Having received this information from both Drs. Alt and Rajewsky, and without any evidence in the record suggesting his colleagues’ comments were unfounded or incorrect, Dr. Murphy nevertheless assisted in authoring the presentation to the PTO that continued to assert that the VelocImmune mouse with 3 VH gene segments was “normal” meaning “identical to wild-type mouse littermates,” ignoring Dr. Rajewsky’s prior lab work and the Zou publications. (DX 2 at 227.)²²

²¹ Dr. David Valenzuela, a recipient of both Dr. Murphy’s email and Dr. Rajewsky’s response, sent a copy of both to Venus Lai (Regeneron’s Executive Director of VelociGene Operations and Trangenics), stating “Venus, this is becoming a bit of an embarrassment, don’t you think?” (DX 120; ECF No. 241 ¶ 93.) Lai responded:

“Very embarrassing...indeed!! I have to comment that I don’t always trust what Drew said or his ideas...I found he often quoted that wrong paper and said the wrong things and no one ever corrected him?! It is really bad that at his level, he should be hold [sic] accountable to the information he provides because everyone takes his words for real. I did correct him a couple of times in the past (when we met 1:1) but I have given up because there’s no point to correct him when it did nothing. I found that in general, some old-timers at Regeneron are not well read and tend to just open their mouths and make big statements as though we are the first (but often these ideas are just copy-cat).” (DX 120 at 10332541; ECF No. 241 ¶ 94.)

Regeneron has argued that the content of this email should be redacted on the basis of possible reputational harm. The Court disagrees. Today, the litigation process frequently exposes records of electronic communications that, in retrospect, may be embarrassing. The Court considers the contents of this email, which do not disclose anything having competitive sensitivity, relevant to this Decision. The Court disagrees with the argument that this statement presents any particularly unusual reputational issues. It is a statement of opinion relevant to the issues before the Court, and it therefore appears without redaction.

²² Notably, after receiving the comments from Drs. Alt and Rajewsky, Dr. Murphy did in fact add the Zou (1994) citation to the paper on which he had requested comments. Dr. Murphy also then submitted his paper regarding the VelocImmune mouse to journals for peer review – and was rejected on the basis that it “lack[ed] sufficient conceptual novelty to be of general interest to the broad readership of [Nature Biotechnology] given that it describes an application of a previously published technology.” (DX 222 at 10034040.)

Following receipt of the January 2013 presentation from Dr. Smeland, the PTO issued an Advisory Action maintaining the rejection of claims 1-19 as anticipated by Lonberg, and claim 20 remained rejected in view of Lonberg and other references. (Id. at 241, 248.) Shortly thereafter, on February 19, 2013, Regeneron retained Brendan Jones, Ph.D., to assist with prosecution. (Id. at 268.) Drs. Jones and Smeland together planned an in-person meeting with the PTO at which Regeneron relied on the previously provided slide deck described above. That meeting occurred on March 11, 2013. (Id. at 290.)

Following that meeting, the Examiner prepared the following notes: “Applicant’s representatives discussed that Lonberg does not teach integration of human unrearranged immunoglobulin genes into an endogenous site of a mouse immunoglobulin locus as required by the instant claims.” (Id.) The Examiner agreed to review the pending application. (Id. at 301.)

On April 26, 2013, the PTO issued a Notice of Allowance for the ‘176 Application. (Id. at 285.) In the statement of reasons for allowance, the Examiner stated that “[t]he prior art does not teach or suggest a genetically modified mouse comprising, in its germline cells, human unrearranged variable region gene segments inserted at an endogenous mouse immunoglobulin locus.” (Id. at 283; ECF No. 241 ¶ 172.) The applicant transmitted the fee on June 28, 2013 and the patent issued as the ‘018 Patent on August 6, 2013. (DX 2 at 328-29, 339; ‘018 Patent.)

IV. LEGAL STANDARDS FOR A FINDING OF INEQUITABLE CONDUCT

Merus asserts that Drs. Smeland and Murphy violated their duty of candor and engaged in inequitable conduct. Merus also alleges that Drs. Smeland and Murphy engaged in egregious affirmative misconduct by, inter alia, making false and misleading statements and including false and misleading results in the January 2013 presentation. Regeneron does not contest that both of these individuals had a duty of candor to the PTO, but vigorously contests whether that duty was violated, whether any non-disclosure rose to the level of inequitable conduct as defined by Therasense, and whether either Drs. Smeland or Murphy engaged in egregious misconduct.

Each individual associated with the prosecution of a patent has a duty of candor and good faith to the PTO. 37 C.F.R. § 1.56(a). This duty includes a “duty to disclose to the Office all information known to that individual to be material to patentability...” Id. The doctrine of inequitable conduct – which can render a patent unenforceable – has origins in those duties as well as a lengthy body of caselaw. In 2011, the Federal Circuit made it clear, however, that the statutory duties of candor and disclosure and the caselaw doctrine of “inequitable conduct” are not always coextensive. See Therasense, Inc. v. Becton, Dickinson & Co., 649 F.3d 1276, 1291-1292 (Fed. Cir. 2011) (en banc).

“As an equitable doctrine, inequitable conduct hinges on basic fairness.” Id. at 1292. “[A]s a general rule, this doctrine should only be applied in instances where the patentee’s misconduct resulted in the unfair benefit of receiving an unwarranted claim.” Id. (citing Star Sci., Inc. v. R.J. Reynolds Tobacco Co., 537 F.3d

1357, 1366 (Fed Cir. 2008)). The Federal Circuit’s en banc decision in Therasense sets forth the governing legal standard. After noting that asserting claims of inequitable conduct had “become a significant litigation strategy” that can “cast a dark cloud over a patent’s validity and paint the patentee as a bad actor” and increase the costs and complexity of infringement litigation, id. at 1288, the Court proceeded to “tighten[] the standards for finding both intent and materiality in order to redirect a doctrine that has been overused to the detriment of the public.” Id. at 1290.

A court’s determination of inequitable conduct proceeds in two parts: the accused infringer, who bears the burden of proof on this claim, must prove both that a nondisclosed reference was material and that the patent applicant acted with the requisite intent. See id.

“[A]s a general matter, the materiality required to establish inequitable conduct is but-for materiality.²³ When an applicant fails to disclose prior art to the PTO, that prior art is but-for material if the PTO would not have allowed a claim had it been aware of the undisclosed prior art.” Id. at 1291. The Court is therefore

²³ The Federal Circuit has explicitly stated that the required level of materiality is not that found in PTO Rule 56. Rule 56 provides that information is material if it is not cumulative and “(1) It establishes, by itself or in combination with other information, a prima facie case of unpatentability of a claim; or (2) It refutes, or is inconsistent with, a position the applicant takes in: (i) Opposing an argument of unpatentability relied on by the Office, or (ii) Asserting an argument of patentability.” 37 C.F.R. § 1.56(b). Importantly, Rule 56 provides that “[a] prima facie case of unpatentability is established when information compels a conclusion that a claim is unpatentable...before any consideration is given to evidence which may be submitted in an attempt to establish a contrary conclusion of patentability.” Id. The Federal Circuit found this definition to be overly broad. See Therasense, 649 F.3d at 1294. The Court stated, “Because Rule 56 sets such a low bar for materiality, adopting this standard would inevitably result in patent prosecutors continuing the existing practice of disclosing too much of the prior art of marginal relevance and patent litigators continuing to charge inequitable conduct in nearly every case as a litigation strategy.” Id. at 1295.

required to place itself in the shoes of a patent examiner and determine whether it would have allowed the claim “if it had been aware of the undisclosed reference.” Id. In making its determination as to materiality, “the court should apply the preponderance of the evidence standard and give claims their broadest reasonable construction.” Id. at 1291-92 (citing Manual of Patent Examining Procedure (“MPEP”) §§ 706, 2111 (8th ed. Rev.8, July 2010)).²⁴

Whether prior art is material is determined by one with ordinary skill in the art. Al-Site Corp. v. VSI Int’l, Inc., 174 F.3d 1308, 1324 (Fed. Cir. 1999). A court can take into account the inferences and creative steps that a person of ordinary skill in the art would employ when deciding whether a claimed combination of prior art would render an invention obvious. DyStar Textilfarben GmbH v. C.H. Patrick Co., 464 F.3d 1356, 1366-68 (Fed. Cir. 2006).²⁵

A finding by a district court that withheld information, such as a prior art reference, renders one or more claims invalid (for instance, by rendering it obvious or anticipated), indicates that the reference is necessarily but-for material. Aventis Pharma S.A. v. Hospira, Inc., 675 F.3d 1324, 1334 (Fed. Cir. 2012); Am. Calcar, Inc. v. Am. Honda Motor Co., 651 F.3d 1318, 1334 (Fed Cir. 2011); Therasense, 649 F.3d

²⁴ In this regard, the Federal Circuit has stated that the patentability of a claim will often “be congruent with the validity determination – if a claim is properly invalidated in district court based on the deliberately withheld reference, then that reference is necessarily material because a finding of invalidity in district court requires clear and convincing evidence, a higher evidentiary burden than that used in prosecution at the PTO.” Therasense, 649 F.3d at 1292.

²⁵ To determine that a patent is invalid based on obviousness requires proof by clear and convincing evidence; that is not the standard the Court applies in its determination of but-for materiality – which is preponderance of the evidence giving the claims their broadest reasonable construction. See Am. Calcar, Inc. v. Am. Honda Motor Co., 768 F.3d 1185, 1189 (Fed. Cir. 2014); Therasense, 649 F.3d at 1291-92.

at 1292 (finding reference was “necessarily material” where the jury and court found reference anticipated asserted claims).

Of particular importance here is the treatment of prior art in connection with other related patent applications. Rejections over withheld prior art in other patent applications with similar claims is evidence of materiality. See Dayco Prods., Inc. v. Total Containment, Inc., 329 F.3d 1358, 1368 (Fed. Cir. 2003) (“We hold that a contrary decision by another examiner reviewing a substantially similar claim meets the Akron Polymer ‘reasonable examiner’ threshold materiality test of ‘any information that a reasonable examiner would substantially likely consider important in deciding whether to allow an application to issue as a patent.’... A prior rejection of a substantially similar claim refutes, or is inconsistent with the position that those claims are patentable. An adverse decision by another examiner, therefore, meets the materiality standard under the amended Rule 56.”); see also, Larson Mfg. Co. of S. Dakota v. Aluminart Prods. Ltd., 559 F.3d 1317, 1339 (Fed Cir. 2009) (“Because the Third and Fourth Office Actions contained another examiner’s adverse decisions about substantially similar claims, and because the Third and Fourth Office Actions are not cumulative to the First and Second Office Actions, the district court correctly found the withheld Office Actions material.”); McKesson Info. Solutions, Inc. v. Bridge Med., Inc., 487 F.3d 897, 918-925.

A reference is not but-for material if it is merely cumulative. See, e.g., Larson, 559 F.3d at 1331; McKesson, 487 F.3d at 913; Dig. Control Inc. v. Charles Mach. Works, 437 F.3d 1309, 1319 (Fed. Cir. 2006) (“However, a withheld otherwise

material prior art reference is not material for purposes of inequitable conduct if it is merely cumulative to that information considered by the examiner.”); Molins PLC v. Textron, Inc., 48 F.3d 1172, 1179 (Fed. Cir. 1995); Litton Indus. Prods. Inc. v. Solid State Sys. Corp., 755 F.2d 158, 167 (Fed. Cir. 1985). A reference is cumulative when it “teaches no more than what a reasonable examiner would consider to be taught by the prior art already before the PTO.” Regents of the Univ. of Calif. v. Eli Lilly & Co., 119 F.3d 1559, 1575 (Fed. Cir. 1997). When a particular reference discloses a limitation of particular importance not elsewhere disclosed, it is not cumulative. McKesson, 487 F.3d at 914. Similarly, when a reference contains a more complete combination of the elements claimed, it is not cumulative even if the elements are before the examiner in other references. Semiconductor Energy Lab. Co. v. Samsung Elecs. Co., 204 F.3d 1368, 1374 (Fed. Cir. 2000).

Finally, the mere existence of differences between a withheld reference and the claims does not, alone, render the reference immaterial. See McKesson, 487 F.3d at 915 (citing Li Second Family Ltd. v. Toshiba Corp., 231 F.3d 1373, 1380 (Fed. Cir. 2000)).

Materiality and intent are separate, independent prongs of the inequitable conduct inquiry. Therasense, Inc. v. Becton, Dickinson & Co., 649 F.3d 1276, 1290 (Fed. Cir. 2011) (en banc). The requisite specific intent to deceive must be proven by clear and convincing evidence. Id. “[A] court must weigh the evidence of intent to deceive independent of its analysis of materiality. Proving that the applicant knew of a reference, should have known of its materiality, and decided not to

submit it to the PTO does not prove specific intent to deceive.” Id. (citing Star Sci., Inc. v. R.J. Reynolds Tobacco Co., 537 F.3d 1357, 1366 (Fed. Cir. 2008)). “To prevail on a claim of inequitable conduct, the accused infringer must prove that the patentee acted with the specific intent to deceive the PTO.” Id. “In a case involving nondisclosure of information, clear and convincing evidence must show that the applicant made a deliberate decision to withhold a known material reference.” Id. (emphasis in original) (quoting Molins PLC v. Textron, Inc., 48 F.3d 1172, 1181 (Fed. Cir. 1995)). The Court stated further, “[i]n other words, the accused infringer must prove by clear and convincing evidence that the applicant knew of the reference, knew that it was material, and made a deliberate decision to withhold it.” Id.

To meet the clear and convincing evidence standard, “the specific intent to deceive must be ‘the single most reasonable inference able to be drawn from the evidence.’” Id. (quoting Star, 537 F.3d at 1366). “Indeed, the evidence ‘must be sufficient to require a finding of deceitful intent in the light of all circumstances.’” Id. (emphasis in original) (quoting Kingsdown Med. Consultants, Ltd. v. Hollister, Inc., 863 F.2d 867, 873 (Fed. Cir. 1988)). Direct evidence of intent is not, however, required; a court may infer intent from circumstantial evidence. Id. An inference of intent to deceive is appropriate where the applicant engages in “a pattern of lack of candor” including where the applicant repeatedly makes factual representations “contrary to the true information he had in his possession.” Apotex Inc. v. UCB, Inc., 763 F.3d 1354, 1362 (Fed. Cir. 2014).

The only exception to the requirement of a showing of but-for materiality is where one owing a duty of candor has engaged in affirmative egregious misconduct. Therasense, 649 F.3d at 1292. “This exception to the general rule requiring but-for proof incorporates elements of the early unclean hands cases before the Supreme Court, which dealt with ‘deliberately planned and carefully executed scheme[s]’ to defraud the PTO and the courts.” Id. (alteration in original) (quoting Hazel-Atlas Glass Co. v. Hartford-Empire Co., 322 U.S. 238, 245 (1944)). The submission of an unmistakably false affidavit has been deemed material misconduct. Id. Other forms of misconduct that have been deemed material include fabricating evidence submitted to the PTO, executing a deliberately planned scheme to defraud the PTO, and concealing a rejection over prior art from a related application. See Apotex, 763 F.3d at 1361-62; Intellect Wireless, Inc. v. HTC Corp., 732 F.3d 1339, 1341-46 (Fed. Cir. 2013). Finding such misconduct material makes sense: “After all, a patentee is unlikely to go to great lengths to deceive the PTO with a falsehood unless it believes that the falsehood will affect the issuance of the patent.” Id. (citing Hazel-Atlas, 322 U.S. at 247).

V. TIMELINE OF THE DUTIES OF CANDOR AND DISCLOSURE

Regeneron’s duties of candor and disclosure spanned the period from February 16, 2001 to partial issuance on August 6, 2013. Dr. Murphy signed the Inventor Declaration when the ‘176 Application was filed in February 2001. (DX 2 at 50-51; ECF Nos. 225, 241 ¶ 71.) He “acknowledged [his] duty to disclose information of which I am aware that is material to the examination of this

application...” (DX 2 at 50; ECF Nos. 225, 241 ¶ 72.) Dr. Smeland worked with others to prepare and prosecute the ‘176 Application. (ECF Nos. 225, 241, ¶ 74; PX 840, Smeland Dep. Tr. at 67:21-24; 70:12-14.) Dr. Smeland has also been involved in litigation efforts against Merus – including the instant litigation – since 2011; he oversaw outside counsel on patent prosecution and litigation. (DX 335, Smeland Dep. Tr. 72:19-25, 81:15-24, 134:4-135:17; DX 184 Entry Nos. 738-40, 745-47, 1327.)

Prior art was raised during the European Opposition and before issuance of the ‘018 Patent. The Notice of Allowance for the ‘018 Patent was issued on April 26, 2013; a European Opposition setting forth various undisclosed references was filed on June 12, 2013, and the ‘018 Patent issued on August 6, 2013.

VI. BROADEST REASONABLE CONSTRUCTION

Based upon the applicable legal standards, the first step in the Court’s inquiry is whether Regeneron failed to disclose but-for material information to the PTO. But-for materiality requires that the Court place itself in the shoes of a patent examiner and determine whether, had the reference(s) been before the examiner at the time, the claims of the patent would have issued. Therasense, 649 F.3d at 1291-92.

In order to determine whether a reference is but-for material, a court proceeds in two steps: first, the Court must determine the broadest reasonable construction (“BRC”) for the claim(s), using principles applicable to claim construction, and second, based on that construction, the Court must determine whether a reasonable patent examiner (who is, by definition, one skilled in the art)

would have allowed the claim(s) had he or she known of the undisclosed information. Am. Calcar, Inc. v. Am. Honda Motor Co., 768 F.3d 1185, 1189 (Fed. Cir. 2014). The BRC is determined based on the claim language itself “in light of the specification as it would be interpreted by one of ordinary skill in the art.” Phillips v. AWH Corp., 415 F.3d 1303, 1316 (Fed. Cir. 2005) (en banc) (quoting In re Am. Acad. of Sci. Tech. Ctr., 367 F.3d 1359, 1364 (Fed. Cir. 2004)). The “broadest reasonable construction” for a claim or term may well be different from that which the court may have previously determined during claim construction, but it cannot be narrower. Facebook, Inc. v. Pragmatus AV, LLC, 582 F. App’x 864, 869 (Fed. Cir. 2014).

There are 20 claims in the ‘018 Patent – of which claims 1, 11 and 20 are the only independent claims.

Claim 1 of the ‘018 Patent provides:

A genetically modified mouse, comprising in its germline human unrearranged variable region gene segments inserted at an endogenous mouse immunoglobulin locus. (‘018 Patent, 29:24-26.)

Claim 11 provides:

A genetically modified mouse, comprising in its germline human unrearranged variable region gene segments linked to a mouse constant region gene, wherein the mouse lacks a human constant region gene, and wherein the mouse constant region gene is at an endogenous mouse immunoglobulin locus. (Id., 29:53-59.)

Claim 20 provides:

A mouse, comprising a modification in the germline of the mouse, wherein the modification comprises:
a. a hybrid heavy chain locus comprising an insertion of human immunoglobulin heavy chain V, D, and J gene segments, wherein

the human heavy chain immunoglobulin V, D, and J gene segments are linked to a mouse immunoglobulin heavy chain gene, wherein the mouse immunoglobulin heavy chain gene is at an endogenous mouse immunoglobulin locus;

- b. a hybrid light chain locus comprising an insertion of human immunoglobulin light chain V and J gene segments, wherein the human V and J gene segments are linked to a mouse immunoglobulin light chain constant region gene sequence; wherein (a) rearranges to form a hybrid heavy chain sequence comprising a human variable region linked to a mouse constant region, and (b) rearranges to form a hybrid light chain sequence comprising a human variable region linked to a mouse constant region, and wherein the mouse is incapable of forming an antibody that comprises a human variable region and a human constant region. (Id., 30:39-64.)

To determine the BRC of claim 1, which is sufficient for this proceeding,²⁶ the Court applies the principles of claim construction set forth in a vast number of decisions of the Federal Circuit. The Court’s goal is to determine the broadest reasonable construction that the claim would have meant “to a person of ordinary skill in the art in question at the time of the invention, i.e., as of the effective filing date of the patent application.” Phillips, 415 F.3d at 1313. The claims of a patent do not stand alone; “[r]ather, they are part of ‘a fully integrated written instrument.’” Id. at 1315 (quoting Markman v. Westview Instruments, Inc., 52 F.3d 967, 978 (Fed. Cir. 1995)). To interpret the meaning – including scope – of a patent’s claims, a court may use intrinsic and, if necessary, extrinsic evidence. See Nazomi Commc’ns, Inc. v. Arm Holdings, PLC, 403 F.3d 1364, 1368 (Fed. Cir. 2005) (instructing courts to look to intrinsic evidence first). Intrinsic evidence includes the claims, the specification, as well as a patent’s prosecution history. See All

²⁶ The Court uses, as Merus did in its submissions in this proceeding, claim 1 as exemplary. Merus’s allegations of unpatentability in view of the Withheld References extend to claims 2-5 as well.

Dental Prodx, LLC v. Advantage Dental Prods., Inc., 309 F.3d 774, 780 (Fed. Cir. 2002) (“Foremost among the tools of claim construction is of course the claim language itself, but other portions of the intrinsic evidence are clearly relevant, including the patent specification and prosecution history.”); see also Phillips, 415 F.3d at 1312 (“It is a ‘bedrock principle’ of patent law that ‘the claims of a patent define the invention to which the patentee is entitled the right to exclude.’” (quoting Innova/Pure Water, Inc. v. Safari Water Filtration Sys., Inc., 381 F.3d 1111, 1115 (Fed. Cir. 2004))).

A basic principle of claim construction is that the claims must be read in light of the specification. See id. at 1315. “[T]he purpose of the specification is to teach and enable those of skill in the art to make and use the invention and to provide a best mode for doing so.” Id. at 1323. One skilled in the art is “deemed to read the claim term not only in the context of the particular claim in which the disputed term appears, but in the context of the entire patent, including the specification.” Id. at 1313. The specification is always “highly relevant” to claim construction analysis; it is the “single best guide to the meaning of a disputed term.” Id. at 1315 (quoting Vitronics Corp. v. Conceptor, Inc., 90 F.3d 1576, 1582 (Fed. Cir. 1996)); see also On Demand Mach. Corp. v. Ingram Indus., Inc., 442 F.3d 1331, 1338, 1340 (Fed. Cir. 2006) (“[T]he scope and outer boundary of claims is set by the patentee’s description of his invention,” and “the claims cannot be of broader scope than the invention that is set forth in the specification.”).

A. The Court's BRC

Applying these principles, the Court finds that the broadest reasonable construction of claim 1 is as follows:

The BRC of “genetically modified mouse” is a mouse, the genes of which have been modified, using the particular LTVEC method described throughout the specification. This interpretation is based on the language of the claim, the specification, and the Court's crediting the testimony of Dr. Davis.

The BRC of “human unrearranged variable region gene segments” is a DNA variable gene segment that is of human origin and that is unrearranged. Unrearranged means that it is in its germline configuration. This interpretation is based on the language of the claim, the specification, and the Court's crediting the testimony of Dr. Davis.

As used in this element, “variable region” includes the V, D and J segments. It also includes the variable regions of both the heavy and light chains.

Notably, the construction of this claim term does not preclude the presence of mouse variable region gene segments, nor does it preclude human constant region gene segments. The sole requirement imposed by this element – read in light of the claim language and the specification – is that there be at least some human unrearranged variable region gene segments, not only those. This is supported by certain of the preferred embodiments set forth above which include some human variable region segments and allow for equivalent mouse segments. For instance, one preferred embodiment is “an embryonic stem cell wherein the mouse heavy

chain variable region locus is replaced, in whole or in part, with a human heavy chain variable gene locus; an embryonic stem cell of claim wherein the mouse kappa light chain variable region locus is replaced, in whole or in part, with a human kappa light chain variable region locus; [and] an embryonic stem cell wherein the mouse lambda light chain variable region locus is replaced, in whole or in part, with a human lambda light chain variable region locus ...” (’018 Patent, 7:6-14 (emphasis added).)

Another preferred embodiment includes an antibody comprising human and non-human constant regions. (*Id.*, 7:19-23.)

Merus argues that the BRC for this element must also include the limitation of a contiguous stretch of human variable region DNA. The Court finds that the broadest reasonable construction does not require such a limitation, though it is a better reading of the requirements set forth in the specification.²⁷ The specification is concerned with a method of genetic modification involving large targeting vectors or LTVECs. A LTVEC is defined as a contiguous fragment of DNA that is more than 20 kb. There is no necessary reason why, for instance, three LTVECS having 20 kb of regions for integration could not be integrated together to form the insertion cassette.

The BRC of “inserted” is just that, “to put into.” To insert something means to add it into. Insertion does not include “deletion.”²⁸ It is different from and not synonymous with “substitution” or “replacement.” The specification

²⁷ This is a broader construction than that the Court determined during claim construction.

²⁸ This too is a broader construction than that the Court determined during claim construction.

distinguishes between insertions, deletions, replacement, and substitution, indicating a distinction between the words. For instance, it states:

“Another embodiment of the invention is a method wherein the genetic modification to the endogenous gene or chromosomal locus comprises deletion of a coding sequence, gene segment, or regulatory element; alteration of a coding sequence, gene segment, or regulatory element; insertion of a new coding sequence, gene segment, or regulatory element; creation of a conditional allele; or replacement of a coding sequence or gene segment from one species with an homologous or orthologous coding sequence from a different species.” (‘018 Patent, 3:40-48 (emphasis added).)

At another point, it states:

“Another embodiment is a method of replacing, in whole or in part, in a non-human eukaryotic cell, an endogenous immunoglobulin variable region gene locus with an homologous or orthologous human gene locus further comprising the steps: e) obtaining a large cloned genomic fragment containing a part of the homologous or orthologous human gene locus that differs from the fragment of (a); f) using bacterial homologous recombination to genetically modify the cloned genomic fragment of (e) to create a second LTVEC; g) introducing the second LTVEC of (f) into the eukaryotic cells identified in step (d) to replace, in whole or in part, the endogenous immunoglobulin variable gene locus...” (Id., 5:61-67, 6:1-5 (emphasis added).)

This interpretation is based on the language of the claim, the specification, and the Court’s crediting the testimony of Dr. Davis.

The BRC of “at” is into or next to – whether the ‘next to’ is upstream or downstream.²⁹ Thus, insertion “at” the Ig locus means in or within the locus – not at a specific point narrower than that. In other words, to use the analogy discussed much earlier in this Opinion, this element of the claim requires that the DNA

²⁹ This is broader than the Court’s claim construction as determined during claim construction.

segment be inserted onto the playing field – there is no requirement that it end up at the 10 yard line, the 30 yard line or the 50 yard line.

This interpretation is based on the language of the claim, the specification, and the Court’s crediting the testimony of Dr. Davis.

The BRC of “endogenous mouse immunoglobulin locus” is the entire endogenous mouse Ig locus, whatever its metes and bounds. It includes both the 5’ and 3’. As the Court found during claim construction, and as both experts agreed during the trial on inequitable conduct, the size, sequence and borders of the locus had not been defined at the time the application was filed on February 16, 2001. (See Trial Tran. 740:16-20.) Thus, if one of skill in the art did not know where the 5’ was located with precision, the targeted insertion anticipated by the ‘018 Patent might occur in the wrong place. The entire point of the targeted insertion is that it be into the Ig locus – not proximate to or close by, but within it.

Regeneron’s internal lab notebooks further confirm that the inventors did not know the length of the locus at the time the application was filed. (ECF No. 105, Clynes Decl. ¶ 43 (“the boundaries for the endogenous mouse immunoglobulin loci were not known in 2001, although it was generally known that they were located somewhere within chromosome 12 (heavy), 6 (kappa) and 16 (lambda)”); ECF No. 210 at 51.)³⁰

Another difficulty with targeting an insertion into the Ig locus is that the size of the locus can change depending on the strain of mouse. (Davis Tr. Decl. ¶ 252.)

³⁰ The Court’s decision on claim construction discusses further evidence supporting the indefiniteness of the 5’ as of February 2001. (ECF No. 210, pp. 51-53.)

Without knowing the strain of mouse, one would not be able to know the precise meets and bounds of the locus.

This interpretation is based on the language of the claim, the specification, and the Court's crediting the testimony of Dr. Davis.

The Court's BRC of Claim 1 as a Whole: Taking these elements together, the Court finds that the broadest reasonable construction of claim 1 allows for the following:

1. A genetically modified mouse that is comprised of human unrearranged variable region gene segments that have been inserted into its Ig locus;
2. The human variable region gene segment may be heavy chain or light chain or both;
3. The constant region of the above mouse may be human or mouse;
4. The mouse variable region may or may not have been deleted;
5. The transmembrane and cytoplasmic tail of the variable region may or may not be human; and
6. The insertion of the unrearranged human variable region gene segments may or may not be functionally linked to the constant region.

During claim construction, the Court construed the claims as follows:

Term	Construction
a genetically modified mouse	A transgenic mouse produced by the process of using LTVECs to modify embryonic stem cells and using a quantitative assay to detect modification of allele in those cells.
human unrearranged variable region gene segments.	A contiguous stretch of cloned human genomic DNA containing variable region gene segments (V, D and J for the heavy chain / V and J for the light chain) in germline configuration, i.e. as it is in the human genome before the development of B cells.
Inserted	One step addition of DNA, without replacing or deleting any native DNA as a result of the addition.
at	Into the locus, as opposed to near the locus, by the locus or around the locus
endogenous mouse immunoglobulin locus	Indefinite as to the metes and bounds of the locus and scope.

B. Regeneron's BRC

At trial, Regeneron's technical expert, Marjorie A. Oettinger, Ph.D., construed the claims of the '018 Patent differently and much more narrowly.

At the outset of this discussion, it is worth noting that throughout this litigation Regeneron has taken vastly different positions on its own construction of its claims. Dr. Oettinger's proposed broadest reasonable construction is far, far narrower than that which Regeneron itself advocated during claim construction. At that time – in July 2014 – Regeneron took the position that claim 1 was a single element and needed no construction – it was plain on its face. That position compares to the following proposed construction, set forth in Exhibit B to Dr. Oettinger's Trial Affidavit – now posited as the broadest reasonable construction:

- Dr. Oettinger construed the element **genetically modified mouse** to mean: “The claimed mouse has a germline genome comprising, at its

endogenous immunoglobulin locus, human unrearranged heavy and/or light chain variable region gene segments inserted at an endogenous mouse constant region such that the human variable region genes are functionally linked, i.e. the resultant mouse is capable of producing an antibody comprising a human variable region and a mouse constant region.” (Oettinger Tr. Aff, Exh. B at 1.)

- Dr. Oettinger construed only the term “unrearranged” in the element **“human unrearranged variable region gene segments;”** she construed that term to mean “not rearranged but capable of rearranging.” (Id. at 3-4.)
- Dr. Oettinger construed the element **“inserted at an endogenous mouse immunoglobulin locus”** to mean: “[m]odified in its germline to insert human unrearranged variable region gene segments at the endogenous mouse immunoglobulin locus functionally linked to mouse constant region gene segments, such that the resultant mouse is capable of producing antibodies comprising a human variable region and a mouse constant region.” (Id. at 6.)
- Dr. Oettinger construes claim 2 as she does claim 1, “wherein the human unrearranged variable region gene segments are heavy chain gene segments, and the mouse immunoglobulin locus is a heavy chain locus.” (Id. at 9.)

- Dr. Oettinger also construes claim 3 as she does claim 1, “wherein the human unrearranged variable region gene segments are light chain gene segments, and the mouse immunoglobulin locus is a light chain locus.” (Id.)
- Dr. Oettinger construes claim 4 as she does claim 3, “wherein the light chain gene segments are human kappa light chain gene segments.” (Id. at 10.)
- Dr. Oettinger construes claim 5 as she does claim 1, “wherein the unrearranged variable region gene segments are contained on a genomic DNA fragment larger than 20 kb.” (Id.)

In sum, Dr. Oettinger construes claim 1 as providing for a genetically engineered mouse, modified in its germline by insertion of human heavy and/or light chain unrearranged variable region gene segments at the endogenous mouse immunoglobulin locus in a manner so as to functionally link those segments with the mouse constant region which is retained in its entirety, and in which the homologous mouse variable region is deleted and no longer present. (See, e.g., Oettinger Tr. Aff. ¶ 111.)³¹ Implicit in her construction is a multi-step process: she

³¹ In this regard the following chronology is notable: in her first report, Dr. Oettinger construed the phrase “genetically modified mouse” of claim 1 to require, *inter alia*, “human heavy and light chain variable region gene loci inserted at an endogenous mouse constant region.” (See Trial Tr. 664:7-11 (emphasis added).) When she was deposed on those opinions, she dropped the word “and” – revising the construction to “human variable region gene loci inserted at an endogenous mouse constant region.” (Trial Tr. 662:3-13, 665:1-17; 668:6-18.) At trial, she modified her construction yet again to “heavy and/or light chain regions.” (Oettinger Tr. Aff. ¶¶ 68, 111, Exh. B; Trial Tr. 681:1-682:8 (emphasis added).) At trial she also changed from requiring operable or functional linkage as part of claim 1 to requiring what she referred to as “proper” insertion of human unrearranged DNA at the mouse Ig locus, i.e. “upstream of the constant region” so as not to “delete the mu enhancer sequence.” (Trial Tr. 686:19-688:18, 734:21-735:20.) Thus, rather than requiring insertion “at” the endogenous

conceded at trial that insertion of variable region heavy chain and variable region light chain gene segments cannot occur simultaneously. (Trial Tr. 665:20-666:4, 675:1-10.) Achieving a fully human variable region therefore requires at least two insertion steps (one for the heavy chain and one for the light chain) and either a deletion step or a breeding step (to breed a mouse with a heavy chain insertion with one with a light chain insertion – however, this would result in rearrangement, thus running afoul of the “unrearranged” limitation). (Trial Tr. 665:18-667:7.) Dr. Oettinger also testified that in addition, to achieve an entirely human variable region would also require a deletion step, in order to remove the mouse variable region segments. (Trial Tr. 690:13-18.)

Dr. Oettinger urged that her construction was supported by concepts she believed were implicit and would be readily apparent to one skilled in the art. In particular, as she understood the goal of the patent to be the creation of therapeutically useful antibodies, achievement of that goal could only occur if, for instance, her imposed limitations were included. A hybrid (human/mouse) variable region would not express therapeutically useful antibodies, and she therefore assumes that the patent avoids the pitfall by requiring insertion of both heavy and light chain variable regions as well as deletion of the murine. She also understands the ‘018 Patent to require placement of the inserted variable regions at just the right place on the playing field – so that they are “functionally linked” to the constant region. Again, without such linkage the resulting antibodies (if any) might

mouse constant region, she altered her construction to require insertion “upstream” of the mouse constant region. (Oettinger Tr. Aff. ¶ 111; Trial Tr. 735:21-736:8, 743:14-744:21.)

well not be therapeutically useful. Dr. Davis disagreed with Dr. Oettinger's implied limitations. The Court finds that his position is supported by substantial evidence and more consistent with that of one skilled in the art as of February 2001. Dr. Oettinger's reading of the Patent is an attempt to reconcile a goal with the claims; if the claims do not achieve the goal, however, it is the claims which are deficient. One cannot simply read into the claims all that may be necessary and desirable to achieve the goal.

Another implicit limitation Dr. Oettinger imposes is on the constant region. She opines that because claim 1 mentions only modifications of the mouse **variable** region, not the mouse constant region, the mouse constant region must be retained in its entirety. According to Dr. Oettinger "there is no mention of inserting human constant region genes or of modifying the mouse constant region in any way" in the specifications. (Oettinger Tr. Aff. ¶ 112.) She is incorrect, as demonstrated by the preferred embodiments which the Court has set out in detail above. Finally, she supports her construction with reference to the presentation Dr. Smeland provided to the PTO that states that the anticipated modification "swap[s] in only human variable regions" and "replace[s] mouse variable region with human in situ, while leaving the normal mouse constant regions intact." (Id. ¶ 114 (alterations in original, emphasis added).) But here again, both Dr. Oettinger and Dr. Smeland err by trying to address an obvious deficiency in claim language by advocacy.

In her trial testimony, Dr. Oettinger references "functional linkage" between the human variable and mouse constant region segments. (Id. ¶ 119.) She asserts

that her use of this phrase does not import a limitation into claim 1; instead, in her view, she is using that concept to “explain that the human variable region gene segments are inserted in such a way that the mouse is capable of undergoing all the necessary steps to eventually transcribe a reverse chimeric antibody gene and produce a reverse chimeric antibody.” (*Id.*) She differentiates this from the use of the word “linked” in claim 8 and the phrase “operably linked” in claim 18 as references to “rearranged human variable region gene segments, not human unrearranged variable region gene segments of claim 1.” (*Id.*) In fact, nothing in claim 1 requires any linkage; this again is an attempt to salvage a claim which could otherwise result in a mouse with a useless Ig locus. Moreover, Dr. Oettinger never persuasively differentiates between being “functionally linked” and “linked” or “operably linked,” which runs her testimony headlong into the doctrine of claim differentiation, which dictates that “different words or phrases used in separate claims are presumed to indicate that the claims have different meanings and scope.” Anderson Corp. v. Fiber Composites, LLC, 474 F.3d 1361, 1369 (Fed Cir. 2007) (quoting Karlin Tech. Inc. v. Surgical Dynamics, Inc., 177 F.3d 968, 971-72 (Fed. Cir. 1999)).

Dr. Oettinger also adds a limitation that the insertion must occur not only in or at the immunoglobulin locus, but upstream of the mouse constant region. She again asserts that this must occur in order for the basic goal of the Patent to create useful human antibodies to occur. In addition, Dr. Oettinger’s construction limits claim 1 to a single preferred embodiment. This is contrary to basic principles of

claim construction. See, e.g., Acumed LLC v. Stryker Corp., 483 F.3d 800, 807 (Fed Cir. 2007) (“[A]lthough the specification often describes very specific embodiments of the invention, we have repeatedly warned against confining the claims to those embodiments.” (quoting Phillips v. AWH Corp., 415 F.3d 1303, 1323 (Fed Cir. 2005))). Dr. Oettinger focuses on Example 3, and particularly LTVEC 1 depicted in Figure 4B, to the exclusion of the other embodiments. (Oettinger Tr. Aff. ¶ 111-12.)

Dr. Oettinger’s construction of claim 1 also embodies additional limitations contained in other claims in the Patent, rendering those claims superfluous. This runs afoul of one of the most basic canons of claim construction that a term should not be construed to contain a limitation already present in some claims but not others. See, e.g., Woods v. DeAngelo Marine Exhaust, Inc., 692 F.3d 1272, 1285 (Fed. Cir. 2012); Amgen Inc. v. Hoechst Marion Roussel, Inc., 314 F.3d 1313, 1326 (Fed. Cir. 2003); Wright Med Tech., Inc. v. Osteonics Corp., 122 F.3d 1440, 1445 (Fed. Cir. 1997).

Dr. Oettinger thus imports into claim 1 limitations found only in other claims: “operably linked” (claim 18), preservation of the mouse constant region (claim 8), requirement of a reverse chimeric or hybrid locus (claim 20), and exclusion of a human constant region (claim 10). The Court asked Dr. Oettinger what she understood to be the difference between claim 1 and claim 11. (Trial Tr. 865:2-867:12, 870:22-871:10, 879:20-880:6.) Dr. Oettinger responded that the “lacks a human constant region gene” limitation of claim 11 permitted a transgene to be inserted randomly into the mouse of claim 1, but not claim 11. Put another way,

claim 1 can include a human constant region gene and claim 11 cannot. (Id. 865:2-866:25.) Dr. Oettinger could not, however, identify any reason why insertion of a human constant region gene would have any value in the invention. (Id. 867:2-871:4.)

Finally, the evidence further established that Dr. Oettinger's reading of claim 1 includes limitations not found in claim 1 but which are found in draft claims of related applications. (ECF No. 310 ¶¶ 116-126.)³²

The Court did not find Dr. Oettinger's construction as stated at trial, or in its two prior iterations, persuasive. The construction as stated at trial is far too narrow given the claim language and the content of the specifications. None of her constructions were supported by the substantial and persuasive evidence that Dr. Davis's constructions were, and her constructions required the addition of words and phrases not present in the claim and that in fact eliminate the differentiation between, inter alia, claim 1 and claim 11.

Dr. Davis's reasoned and well-supported criticism of these constructions was manifold.

First, he convincingly supported the position that insertion "at the endogenous" immunoglobulin locus was not sufficiently defined in 2001 to allow one

³² After Regeneron disclosed the Withheld References in those applications, the Examiners rejected those claims. (ECF No. 310 ¶¶ 113-115, 129-130, App. B.) Regeneron then added limitations such as operably linked/operable linkage to a mouse constant region in an attempt to overcome the rejection in light of the WR. (Id. ¶ 131, App. B.) This further demonstrates that Regeneron did not view such a limitation as inherent in claim 1 in the '018 Patent or initial drafted claims of related applications. (Id. ¶ 347.)

skilled in the art to practice the invention. The metes and bounds of the 5' of the locus were unknown. (Davis Tr. Decl. ¶ 100.)

Second, he convincingly argues that the LTVEC method which is central to the Patent was not enabled in 2001. (Id. ¶ 101.)

The evidence is overwhelming that Dr. Oettinger's construction is not a "broad" construction at all – let alone the "broadest reasonable" construction. It is exceedingly narrow – perhaps the narrowest possible construction. This is a finding of fact based upon the Court's review of the record in light of how Dr. Davis opined one of ordinary skill in the art would understand the claim as of 2001 (this determination necessarily includes the Court's factual determination as to what one skilled in the art would include within various scientific concepts within the claim, so the Court's determination is not and could not be one solely of law).

VII. MATERIALITY OF THE WITHHELD REFERENCES

Using the BRC of the '018 Patent, the Court next examines the information allegedly withheld from the PTO. The Court's task is to determine whether, construing the terms pursuant to the BRC, the PTO would have allowed the claims had such information been before it. Four references known to Regeneron's Drs. Smeland and Murphy were not disclosed to the PTO during patent prosecution:

1. DX 70 – Marianne Brüggemann & Michael S. Neuberger, "Strategies for Expressing Human Antibody Repertoires in Transgenic Mice", 17(8) Review Immunology Today 391 (1996) ("Brüggemann");
2. DX 6 – WIPO Patent Publication No. WO 91/00906 entitled "Chimeric and Transgenic Animals Capable of Producing Human Antibodies" credited to Clive Wood et al. ("Wood");

3. DX 78 – Shinsuke Taki et al., “Targeted Insertion of a Variable Region Gene into the Immunoglobulin Heavy Chain Locus”, 262 *Science* 1268 (1993) (“Taki”); and

4. DX 72 – Yong-Rui Zou et al., “Cre-*loxP*-mediated Gene Replacement: A Mouse Strain Producing Humanized Antibodies”, 4(12) *Current Biology* 1099 (1994) (“Zou”).³³

These references are referred to collectively as the “Withheld References” or “WR”.

In addition, Merus asserts that during prosecution of the ‘018 Patent, Regeneron failed to disclose Merus’s Statement of Facts and Arguments (“Merus’s Brief”) or Kymab’s Statement of Facts and Arguments (“Kymab’s Brief,” together the “European Opposition Briefs”), in opposition to European Patent No. 1,360,287. (See DX 380, Regeneron’s First Supplemental Responses to Fifty of Merus’s Requests for Admission, Nos. 61-64, 83-84.)

The principal question before the Court is whether, individually or collectively, these references meet the rigorous but-for standard of materiality required by Therasense.³⁴ They do. The “PTO would not have allowed [this] claim had it been aware of the undisclosed prior art.” Therasense, Inc. v. Becton, Dickinson & Co., 659 F.3d 1276, 1291 (Fed Cir. 2011) (en banc). In making this determination, the Court “appl[ies] the preponderance of the evidence standard and give[s] claims [in the ‘018 Patent] their broadest reasonable construction.” Id. at

³³ In response to requests for admission, Regeneron admitted that Dr. Smeland did not disclose any of the four references to the PTO. (RFAs 49-56.)

³⁴ As discussed below, a second principal question is of course intent. Here, due to the discovery misconduct which the Court has found and which was extraordinary by any standards, the Court imposes the sanction of an adverse inference as to intent.

1291-92 (citing Manual of Patent Examining Procedure (“MPEP”) §§ 706, 2111 (8th ed. Rev.8, July 8, 2010)).

Importantly, and supportive of this Court’s determination, each of the Withheld References has formed a part of the basis for either outright rejection or other action by the PTO in connection with other applications in the same family of patents.

The Court discusses its determinations with regard to each of the Withheld References below.

A. Brüggemann

The parties have focused particular attention on one section in the Brüggemann reference: “Replacing mouse Ig genes with human genes.” (DX 70 at 394.) That section states:

The approaches described above involve the random integration of exogenous mouse human transloci into the mouse genome; these transgenic animals are then crossed with mice carrying disruptions of their own endogenous Ig loci. An attractive alternative would be to replace the mouse Ig loci with the human Ig loci; in this way it might also be possible to retain and exploit any possible regulatory sequences in the mouse loci that are located distal to protein-coding regions. While such ambitions have not been realized, successful replacement of small portions of the mouse genome have been described...[citing, inter alia, Zou]...Furthermore, technologies for directed gene replacement (e.g. using the Cre–*loxP* system) might allow the generation of animals in which much of the DNA of the mouse Ig loci is substituted by human Ig-gene DNA. (Id. at 394-95 (emphasis added).)

Notably, Brüggemann cites to Zou (another Withheld Reference) to accomplish partial replacement of the mouse Ig locus with human Ig DNA.

Dr. Davis testified credibly that, more particularly, Brüggemann teaches integrating human unrearranged variable region gene segments into the Ig locus. (Davis Tr. Decl. ¶¶ 81, 115.) He also persuasively opines that this reference also discloses that “directed gene replacement” allows much of the DNA of the mouse Ig loci to be substituted by human DNA. (Id. ¶ 81.) In addition, use of the phrase “much of” would have been reasonably understood by one of skill in the art to refer to a replacement in whole or in part, which is similar to the “in whole or in part” references in the ‘018 Patent; and also allows for insertion of an entirely human gene segment and retaining an entirely mouse gene segment, just as in the ‘018 Patent. (Id. ¶ 82.)

Finally, the evidence clearly establishes that Brüggemann discloses the desirability of inserting human gene segments into the mouse Ig locus. Brüggemann provides the explicit motivation of having the ability to exploit regulatory sequences “distal to protein-coding regions.” (DX 70 at 394; Davis Tr. Decl. ¶ 81.)

The Court finds that Brüggemann is but-for material and that the PTO would not have allowed claims 1-5 of the ‘018 Patent had Brüggemann been before the Examiner.

B. Wood

The parties have focused particularly on “Example 2” from the Wood reference. That example states:

Construction of an Unrearranged Human Ig Gene in a Cosmid Vector

Another unrearranged DNA fragment construct according to this invention comprises an unrearranged human V_H gene segment, the human J_H locus, with a single upstream, unrearranged D segment, the murine μ [mu] gene including its upstream μ [mu] switch region, the murine gamma 2b switch region, the human gamma 1 coding region. The murine μ [mu] may be changed for the human μ [mu] region, since both regions have been found to signal allelic exclusion in the transgenic mouse models. (DX 6 at 32:10-20.)

Wood discloses insertion of human variable region gene segments upstream of an endogenous mouse constant region, to produce a genetically modified mouse. (Id. at 1:4-9, 2:8-25, 6:11-20, 9:7-10; 9:19-10:10, 19:13-18, Davis Tr. Decl. ¶¶ 91-93.) Wood indicates that a skilled artisan may take advantage of the endogenous mouse μ (mu) constant region (that is, from the animal itself), or may alternatively produce a transgene that includes human V, D and J segment(s), that adds an exogenous mouse μ (mu) constant region. (DX 6; Davis Tr. Decl. ¶¶ 91-93.) A skilled artisan would understand that Wood teaches a targeted insertion of exogenous human V, D and J gene segments (or contiguous genomic unrearranged human variable region gene segments) at the mouse locus to be used in conjunction with the endogenous mouse constant region. (DX 6; Davis Tr. Decl. ¶¶ 91-94.) Wood also motivates a person of ordinary skill in the art to use an endogenous mouse constant μ (mu) region for purposes of allelic exclusion. (DX 6; Davis Tr. Decl. ¶ 93.) One skilled in the art would understand Wood to be disclosing the possibility of a reverse chimeric mouse, or a mouse with a reverse chimeric locus. (In this regard, he also cites K.R. Thomas et al, for techniques for obtaining chimeric and transgenic animals.) (DX 6 at 20:4-6; Davis Tr. Decl. ¶ 95.)

Dr. Oettinger argues that because the insertion disclosed in Wood is not targeted at the Ig locus, not all of the benefits provided by the '018 Patent are present. (Trial Tr. 856:21-858:5) It is certainly true that Wood does not target insertion at the Ig locus, but nor does he exclude insertion at the locus. Thus, Wood is appropriately understood as including but not limiting insertion at the Ig locus. To the extent that insertion occurs outside the locus, it is possible – though there is no actual evidence in the record apart from Oettinger's ipse dixit – that all the benefits that could result from the '018 Patent might not be available. This, however, overlooks the fact that the '018 Patent allows for targeted insertion without deletion of the homologous mouse gene segment, potentially also decreasing or even eliminating the hoped-for benefits, and if the insertion occurs in a location not functionally linked to the mouse constant regions, there could also be a diminution or elimination of benefits. Thus, there is no evidence from which the Court can draw a conclusion that fewer benefits are necessarily available from Wood than from the '018 Patent.

The Court finds that Wood is but-for material and that the PTO would not have allowed claims 1-5 of the '018 Patent if Wood had been before the Examiner.

C. Taki

The Taki reference describes the targeted insertion of rearranged mouse variable region into the Ig locus. (DX 78, at 1266.) The parties have appropriately focused on the entirety of the article. The key point of disagreement between the parties' technical experts is whether targeted insertion of rearranged mouse

variable region gene segments is sufficiently different from targeted insertion of unrearranged human variable region gene segments to render this reference immaterial. As a matter of law, the mere existence of differences between a withheld reference and the claims does not, alone, render the reference immaterial. See McKesson Info. Solutions, Inc. v. Bridge Med., Inc., 487 F.3d 897, 915 (Fed Cir. 2007) (citing Li Second Family Ltd. v. Toshiba Corp., 231 F.3d 1373, 1380 (Fed. Cir. 2000)).

Dr. Davis has provided persuasive testimony and support for his position that the reference is material – and that the difference of “rearranged” versus “unrearranged” does not undermine that materiality. Taki states, in part:

We designed a targeting vector in order to introduce a rearranged V_H region gene ... into a chromosomal position where rearranged V_H genes locate, 5' to the heavy chain enhancer.... A successful targeting event would yield an IgH locus carrying the V_H T15 gene in the position of J_H ... (DX 78 at 1268.)

The evidence before the Court overwhelmingly supports but-for materiality of Taki. Taki teaches targeting at the specific locus – the Ig locus – with operable linkage (the V_HT15 gene would be in the position of the J_H segment and thus proximate to the mouse constant region), taking advantage of the mouse regulatory and constant regions. Taki, in short, provides the motivation to target human variable region DNA into the mouse Ig locus. Taki contrasted the mouse disclosed by this reference (a second generation mouse) with one made with random integration – such as that by Lonberg. During prosecution of the '018 Patent, Dr. Smeland similarly argued that the targeted insertions into the Ig locus was a point

of difference from Lonberg. As a result, Dr. Smeland's argument itself further reinforces the persuasive evidence that Taki is not cumulative of Lonberg. In addition, Taki articulates several of the benefits that Dr. Smeland told the patent Examiner had never before been recognized (DX 2 at 163), and which Dr. Smeland argued were "entirely unexpected" by producing antibodies from an endogenous mouse Ig locus. (Id. at 211 (arguing that it was unexpected that mice having exogenous human Ig DNA inserted at the mouse Ig locus "would exhibit essentially normal B cell development and have essentially normal immune systems..."); Davis Tr. Decl. ¶ 57.) Clearly, the fact that Taki discloses those same benefits and results disputes the novelty Dr. Smeland asserted with regard to the '018 Patent.

The Court finds that the Taki reference is but-for material and that the PTO would not have allowed claims 1-5 of the '018 Patent if Taki had been before the Examiner.

D. Zou

The Zou reference concerns Cre-*loxP*³⁵ recombination, a type of recombination carried out by a bacterial enzyme and not homologous recombination. The '018 Patent refers to use of a *loxP* technique in Figures 4C and 4D as well. The parties have focused on the entirety of the reference. The article begins:

The bacteriophage-derived Cre-*loxP* recombination system operates efficiently in mammalian cells. This system is particularly useful in gene-targeting experiments in the mouse, and has already been used to

³⁵ The term "Cre-*loxP*" refers to a method for the introduction of genetic modifications into specific genes by homologous recombination using Cre a site-specific, bacteriophage P1-derived recombinase. The Cre recombinase cuts at the *loxP*-tagged genes.

generate 'clean' deletions of target genes in the germ line, as well as to inactivate target genes in a conditional manner.

....

Results: We used the Cre-*loxP* system, in mouse embryonic stem cells, to replace the mouse gene C γ 1, which encodes the constant region of the heavy chain of IgG1 antibodies, with its human counterpart. The mutation was transmitted through the mouse germ line, and the resulting mutant mice were crossed with mice expressing κ [kappa] light chains with a human, instead of a mouse, constant region. Mice homozygous for both mutations produce humanized κ [kappa]-chain-bearing IgG1 antibodies at the same level and efficiency as wild-type mice produce murine antibodies.

...

Conclusions: Cre-*loxP*-mediated gene replacement is a simple and efficient general method of targeted mutagenesis in the mouse. (DX 72 at 1099.)

Later in the article, Zou et al. described their results more fully:

We used Cre-*loxP*-mediated gene replacement in our attempt to generate a mouse strain that would produce antibodies with constant (C) regions of human rather than mouse origin.... In these mutants, the entire C γ 1 gene is replaced by its human counterpart, except for the exons encoding the transmembrane and cytoplasmic portions of the γ 1 chain; we hoped in this way to minimize the danger of disturbing membrane expression and signaling of the humanized IgG1 in the mouse. (Id. at 1100.)

Zou teaches targeted insertion of human gene segments into an endogenous mouse Ig locus. The resulting mouse would have human constant region gene segments, but would retain murine transmembrane and cytoplasmic tail gene segments.

The evidence convincingly demonstrates that to one skilled in the art, Zou teaches targeted insertion of human Ig DNA into the mouse Ig locus and notes that doing so produces humanized antibodies at the same level of efficiency as wild-type

mice. Thus, it teaches the very same benefits that Regeneron's Dr. Smeland represented to the PTO were novel and unexpected. This reference further teaches the importance of retaining the transmembrane and cytoplasmic tail of the mouse constant region to achieve normal production of antibodies. This reference provides significant motivation to target the mouse Ig locus with human Ig DNA.

The Court finds that the Zou reference is but-for material and that the PTO would not have allowed claims 1-5 of the '018 Patent if Zou had been before the Examiner.

E. Withheld References as a whole

It is also helpful to place the claim language of the '018 Patent directly alongside the Withheld References.

A genetically modified mouse: this alone was not novel or asserted by Regeneron to be the basis for the novelty of its invention. (See Davis Tr. Decl. ¶¶ 105-06.) Long homology arms were, for instance, previously known in the art. (See, e.g., DX 77; DX 9, U.S. Patent No. 6,069,010 at Figs. 2A-C, 4:3-16; Davis Tr. Decl. ¶ 107.)

Comprising in its germline: Zou teaches germline modifications to the mouse in the form of modifications of integrated human Ig DNA that were passed down to subsequent generations. Brüggemann reports Zou's germline transmissions. (Davis Tr. Decl. ¶ 111.) Wood taught a chimeric or transgenic non-human eukaryotic animal having incorporated into its germline unrearranged DNA fragments bearing exogenous Ig gene segments. (Id. ¶ 112.) Taki taught "a method

of generating ‘second generation’ Ig transgenic mice, in which the transgene behaves like a normal rearranged Ig gene in terms of B cell-specific expression, class switching, and somatic hypermutation.” (Id. ¶ 113.) Taki also notes production of a mouse “strain” – suggesting germline modification. (Id.)

Human unrearranged variable region gene segments: Brüggemann teaches the desirability of inserting a human Ig locus into a mouse Ig locus. (Id. ¶ 115.) Zou and Taki both teach methods with respect to a contiguous set of human V, D, and J gene segments (heavy chain) and V and J (light chain). (Id.)³⁶

Inserted at an immunoglobulin locus: Taki, Zou, Brüggemann, and Wood all provide specific motivation for targeting into the endogenous mouse Ig locus to produce a genetically modified mouse, and one that is capable of producing humanized antibodies having normal somatic hypermutation and isotype switching. (Id. ¶ 125.) Taki taught targeted insertion of a variable region gene into the mouse Ig heavy chain locus. (Id. ¶ 127.) Moving from this to the light chain locus was not a substantial step. Moreover, Zou taught replacing a heavy-chain C-region gene with a human counterpart, and combining this mutation with a similar one in the κ [kappa]-chain locus, resulting in a mouse strain with κ [kappa]-chain bearing IgG1 antibodies with human instead of mouse constant regions. (Id.) Zou also taught single step insertion (that is, insertion without deletion) followed by deletion.

In addition, Dr. Davis persuasively opined – with support – that a skilled artisan could combine the teachings of Wood and Taki and/or Zou to identify the

³⁶ As discussed below, interpretations by various examiners of related applications (the ‘842 and ‘473) also cited Brüggemann to make a similar point. (See also Davis Tr. Decl. ¶ 120, 122.)

region within the locus for targeted insertion of human unrearranged variable region gene segments. (Id. ¶ 133.)

Claim 2: Claim 2 differs from claim 1 insofar as the DNA inserted is human unrearranged variable heavy chain, targeted to the heavy chain locus. Taki, Zou, and Brüggemann all teach targeting the endogenous heavy chain locus. Use of heavy chain variable DNA is described by Taki (for mouse rearranged), in Wood (for human unrearranged variable region segments), and more generally in Brüggemann. (Id. ¶ 135.)

Claims 3 and 4: Claim 3 differs from claim 2 in that it is concerned with unrearranged variable region light chain (inserted into the Ig locus). Taki, Zou, Brüggemann and/or Wood disclose instructions and motivations for targeting specific known regions of the light chain locus with homologous human DNA. (Id. ¶ 136.) Zou and Wood both specifically disclose modifications of the light chain. (Id.)

Claim 5: Claim 5 requires the unrearranged variable region to be greater than 20 kb. As discussed below, Yang discusses this, as does Kucherlapati. A person reading the teachings of Zou, Taki, Brüggemann, and Wood would, in light of the art at that time, have the information to produce a mouse with the elements of claim 5. (Id. ¶ 138.)

Beyond this, Dr. Davis persuasively opines – with support – that even using Dr. Oettinger’s flawed claim constructions, the Withheld References are nonetheless but-for material. (Id. ¶¶ 145-64.) The Court agrees with Dr. Davis’s views in this regard.

Regeneron's repeated explanation as to why the Withheld References are not but-for material is that the '018 Patent discloses a reverse chimeric mouse, one that features human variable and mouse constant regions in the mouse Ig locus. This argument ignores the essential point that claim 1 allows for a partially human/partially mouse variable; the same is true for the constant region. Thus, focusing on the novelty of entirely human variable is fundamentally inaccurate.

With regard to Brüggemann, Regeneron specifically argues that this reference concerns replacing an entire mouse Ig loci with an entire human while the '018 Patent teaches retaining an entirely mouse constant. In fact, as described elsewhere herein, the '018 Patent also allows for a human or mouse constant. As for Zou, Regeneron primarily reiterates the cumulativeness arguments this Court rejects below.

F. The European Opposition Briefs

Davis testified credibly that a skilled artisan reading the European Opposition Briefs would recognize the key teachings of the Withheld References and how they applied to the '018 Patent. (Id. ¶¶ 238-54.) The European Opposition briefs discuss each of the Withheld References in detail. The evidence at trial persuasively supports them. A skilled artisan would have understood that, as a result, the Withheld References were (if accurately described in the briefs) material. (Id. ¶ 254.) A skilled artisan reading both the Opposition Briefs and then the references themselves would have been able to confirm the faithful and accurate description of the references in those briefs and would have thus been led

inexorably to an understanding of their relevance and but-for materiality. (Id.) Kucherlapati and the European Opposition Briefs, read together – again, with confirmation of a faithful description of the references – would have prevented issuance of claims 1-5 of the ‘018 Patent. (Id.)

The Court finds that if the European Opposition Briefs had been read together with the references that were already before the Examiner, the Examiner would have understood the relevance and but-for materiality of the four WR discussed in detail above. The Court finds that one skilled in the art would therefore understand that the Opposition Briefs are but-for material and that the PTO would not have allowed claims 1-5 of the ‘018 Patent they had been before the Examiner.

VII. CUMULATIVENESS OF THE WITHHELD REFERENCES

Regeneron argues that even if the Withheld References and the European Opposition Briefs are material in some sense (a point it vigorously contests), they are in all events cumulative of references that were disclosed to the PTO, particularly Kucherlapati,³⁷ Lonberg, and Jakobovits. (See ‘018 Patent, References Cited.) The parties introduced extensive evidence at trial as to whether these three references render the Withheld References and the European Opposition Briefs cumulative. Based on the persuasive and well supported testimony of Dr. Davis,

³⁷ References to “Kucherlapati” refer to U.S. Patent No. 6,114,598, issued to Raju Kucherlapati et al. on June 5, 1995. (See DX 5.)

and the Court's assessment of the less persuasive and shifting explanations by Dr. Oettinger, the Court finds that they do not. (Davis Tr. Decl. ¶¶ 201-37.)

Far from cumulative, each of the Withheld References provides specific teachings, disclosure and motivation for performing targeted insertion of exogenous DNA into the Ig locus that are not contained in what the Examiner already had before it (including, *inter alia*, Kucherlapati, Lonberg, and Jakobovits.) (Davis Tr. Decl. ¶¶ 201-206.) One skilled in the art and who had knowledge of each of the Withheld References as well as Kucherlapati, Lonberg and Jakobovits, would understand that the genetically modified mouse disclosed in claim 1 of the '018 Patent was disclosed by the Withheld References but not in the prior art that was shared with the Examiner. (Davis Tr. Decl. ¶ 203-04.) Indeed, at several points in patent prosecution Regeneron itself focused on the shortcomings of the disclosed prior art to argue in favor of the instant application, and thereby highlighted the fact that certain aspects disclosed in the Withheld References did not appear in the prior art shared with the Examiner and thus that the references were not all cumulative of one another. The Court finds that an Examiner with such knowledge would not have allowed claims of the '018 Patent.

A. Kucherlapati

The evidence demonstrates that Regeneron argued in European Opposition proceedings that Kucherlapati was not enabled. (Davis Tr. Decl. ¶¶ 201-17, 220.) As a matter of law, a reference to a non-enabled device cannot render a reference to an enabled device cumulative. Cf. In re Antor Media Corp., 689 F.3d 1282, 1287

(Fed. Cir. 2012) (“A prior art reference cannot anticipate a claimed invention ‘if the allegedly anticipatory disclosures cited as prior art are not enabled.’” (quoting Amgen Inc. v. Hoechst Marion Roussel, Inc., 314 F.3d 1313, 1354 (Fed. Cir. 2003))).

But in addition, the evidence demonstrates that Kucherlapati does not contain the same teachings and motivations disclosed in Taki. (Davis Tr. Decl. 227-35.) Taki is more specific in terms of targeting. As discussed above, Taki discloses targeting exogenous variable region DNA at a specific position upstream of the 5’ heavy chain enhancer and mouse constant region. This specific integration allows for the exogenous Ig DNA to express and experience good somatic hypermutation, isotype switching and B cell development. In contrast, Kucherlapati discloses only vague targeting.

Taki also provides different motivations than Kucherlapati: Taki includes the motivation to target the endogenous mouse Ig heavy chain locus with functional exogenous variable region DNA to allow the exogenous Ig variable region DNA to “participate in isotype switching and undergo somatic hypermutations.” (Id. ¶ 227.) Kucherlapati does not. (Id. ¶ 228.) Taki reports that “present data establish a method of generating ‘second generation’ Ig transgenic mice, in which the transgene behaves like a normal rearranged Ig gene in terms of B cell-specific expression, class switching, and somatic hypermutation.” (Id. ¶¶ 229, 233; DX 78 at 1270.) No reference before the PTO disclosed this.

Nor is Kucherlapati cumulative of Zou. (Davis Tr. Decl. ¶ 220.) Zou discloses a genetically modified mouse having human Ig DNA inserted into the mouse heavy

chain locus, and breeding that with a genetically modified mouse having human Ig DNA inserted into the mouse kappa chain locus. (Id. ¶ 221.) This is not disclosed in any of the references before PTO, including Kucherlapati. In addition, Zou discloses the importance and benefits of maintaining the endogenous mouse transmembrane and the cytoplasmic tail, “to minimize the danger of disturbing membrane expression and signaling of the humanized IgG1 in the mouse.” (DX 72 at 1100; see also Davis Tr. Decl. ¶ 71.) This, in turn, leads to the substantial benefit of a mouse which produces antibodies at the same level and efficiency as wild-type mice. These disclosures of technique, benefit and motivation were not disclosed in Kucherlapati.

Kucherlapati is also not cumulative of Wood. (Davis Tr. Decl. ¶ 237.) Wood instructs the use of the endogenous mouse μ (mu) region – Kucherlapati does not. Indeed, Kucherlapati deletes and replaces the endogenous mouse μ (mu) region. In addition, Kucherlapati’s motivation for targeting the mouse Ig locus is for transformation efficiency, not to utilize the endogenous mouse μ (mu) constant region. (Id.)

Finally, Kucherlapati is also not cumulative of the Brüggemann reference. Brüggemann teaches the benefits of targeted insertion as taking advantage of the regulatory regions distal to the protein-coding regions and the expectation that mouse regulatory sequences distal to the protein coding regions will remain intact. (Id. ¶ 208.) In contrast, Kucherlapati states that “the xenogeneic locus will be placed substantially in the same region as the analogous host locus, so that any

regulation associated with the position of the locus will be substantially the same for the xenogeneic immunoglobulin locus.” (DX 5, 10:51-55.)

B. Lonberg & Jakobovits

Lonberg similarly does not render Brüggemann cumulative. Lonberg did not teach targeted insertions of functional DNA into the mouse Ig locus, and simply used random integration to add functional human Ig DNA. (Davis Tr. Decl. ¶ 218.) One example of the lack of cumulateness is evident in a comparison of Lonberg, Kucherlapati, and Jakobovits (individually or collectively) to Wood. Wood teaches a DNA construct which includes human V, D and J segments, including human unrearranged variable region gene segments, and that this construct may be used in conjunction with the endogenous mouse mu region, prior to recombination. Wood also discloses use of the μ (mu) constant region from the mouse itself. (DX 6.) None of the references before the PTO, including Kucherlapati, Lonberg or Jakobovits disclose these things.

Additionally, unlike the Withheld References, both Lonberg and Jakobovits refer to a “knock-out”³⁸ plus transgene mouse made via random insertion. None of the Withheld References require knock-out, and each discusses targeted – not random – insertion. Moreover, the Jakobovits ‘364 Patent only targets the mouse Ig locus to insert lox sites, not exogenous functional Ig DNA. The insertion of lox sites is the first step in that patent’s goal of modifying hybridomas, not insertion of immunoglobulin gene segments into a transgenic mouse. (Davis Tr. Decl. ¶ 221

³⁸ The ‘018 Patent defines “gene knockout” as genetic modification resulting from disruption of the genetic information encoded in a locus. (‘018 Patent, 9:16-18.)

n.189.) In sum, unlike the Withheld References, Jakobovits provides no motivation to target the mouse Ig locus with exogenous DNA. Finally, Lonberg does not teach insertion of human Ig DNA into an endogenous mouse Ig locus and therefore also provides different motivation than that evident in the Withheld References. (Davis Tr. Decl. ¶ 219.)

Based on the evidence of how one skilled in the art would understand the references before the Examiner compared to the Withheld References, the Court finds that the Withheld References are not cumulative. This is a finding of fact by the Court.

VIII. THE BASIS OF OTHER REJECTIONS³⁹

The '018 Patent is only one of a large number of related patents or applications in the same family. In connection with prosecution of related applications with substantially similar claims, Regeneron's patent counsel have filed disclosure forms ("IDS") specifically referencing the Withheld References. The prosecution history with regard to these patents and applications is highly relevant to the issue of the but-for materiality of the Withheld References. As set forth below, Examiners have found that Taki, Brüggemann, and Wood, three of the Withheld References at issue here, form a basis for rejection of claims substantially

³⁹ Regeneron argues that rejections of other applications is not equivalent to proving but-for materiality. The Court agrees. Nevertheless, the ways the PTO treated the Withheld References when considering claims substantially similar to those in the '018 Patent are, without a doubt, probative of the Withheld References' materiality.

similar to claim 1 (as well as others) in the '018 Patent. (See, e.g., Davis Tr. Decl. ¶165 et seq.)⁴⁰

A. Rejections by the PTO

The list of applications in which claims substantially similar to the claims in the '018 Patent were rejected on the basis of the references Regeneron withheld during prosecution of the '018 Patent is extensive. The Court considers a few relevant examples.⁴¹ Consider first U.S. Patent Application Number 11/809,473. (DX 17.) Claims 1, 8, and 9 of the '473 Application were similar to claims 1 and 5 of the '018 Patent: the two sets of claims each refer to modifying a mouse endogenous chromosomal locus by using a targeting vector to insert a genomic fragment larger than 20 kb and then using an MOA assay to detect modification. (Id. at 200.) However, Brüggemann was disclosed in the prosecution of the '473 Application, and the PTO cited it as a basis to reject the overlapping claims on obviousness grounds. (Id. at 214.) The basis for this rejection is thus probative of whether the Brüggemann reference was but-for material.

The Court also considers U.S. Patent Application No. 13/719,842. (DX 16.) This Regeneron applications contain claims largely similar to claims 1 and 2 of the '018 Patent. For example, claim 4 of the '842 Application concerns “insertion” of

⁴⁰ While Zou has not itself been cited in rejections, Zou is cited and relied upon in the Brüggemann reference here at issue. “Zou informs the skilled artisan of the particular regions within the mouse locus that are important for producing humanized antibodies at the same level of efficiency as wild-type mice.” (Davis Tr. Decl. ¶ 187.)

⁴¹ The Court finds that all of the examples described advance claims sufficiently similar to those in the '018 Patent to make the Examiners' treatment of the Withheld References relevant to the materiality of those references in the prosecution of the '018 Patent.

“unrearranged human immunoglobulin sequences” “at” “a non-human immunoglobulin locus,” while claim 9 concerns performing this method in “a mouse cell.” (Id. at 39.) This claim compares with claim 1 of the ‘018 Patent, which concerns “[a] genetically modified mouse, comprising in its germline human unrearranged variable region gene segments inserted at an endogenous mouse immunoglobulin locus.” (‘018 Patent, 29:24-26.)

During the application process for the ‘842 Application, Dr. Smeland produced an IDS that identified the same material submitted in an IDS in connection with prosecution of the ‘018 Patent; that is to say, that did not contain the Withheld References. (Id. at 76-80.) Although Brüggemann was not included in Dr. Smeland’s IDS, it was part of the basis for the PTO’s initial rejection of claims 3, 4, 8, and 9; the examiner stated that “Brüggemann et al. teach that an attractive alternative of the mice would be to replace the mouse Ig locus with the human Ig locus; in this way, it might also be possible to retain and exploit any possible regulatory sequences in the mouse loci that are located distal to the protein-coding regions.” (Id. at 95-96 (emphasis in original).)

After Regeneron amended the claims in the ‘842 Application and the PTO maintained its rejection of claims 3, 4, 8, and 9 on the basis of, inter alia, Brüggemann, a Third Party Submission (“TPS”) disclosed Taki and described its relevance and materiality to the pending claims. (Id. at 147.) Dr. Smeland then submitted an additional IDS that contained the Brüggemann, Taki, and Zou Withheld References. (Id. at 172-74.) Subsequently, the Examiner rejected all of

the pending claims in the '842 Application in view of several references, including Taki and Lonberg. (Id. at 276.) Regeneron's appeal of the rejection is pending. As with the '473 Application, the role Brüggemann and Taki played in the rejection of the claims in the '842 Application that are similar to the claims in the '018 Patent tends to prove the materiality of those references.

In another example, U.S. Patent Application No. 13/719,819, several claims were so similar to those in the '018 Patent that the Examiner initially rejected them on grounds of nonstatutory double patenting. (DX 18, at p. 164-65.) The Examiner also rejected these claims, which it labeled "not patentably distinct from" the claims in the '018 Patent, on the ground that Taki, when combined with Lonberg and other references, made the claims in the '819 Application so "prima facie obvious" that they only amounted to "combining prior art elements according to known methods to yield predictable results," and in a manner that "[o]ne of ordinary skill in the art would be motivated to do." (Id. at 163.) This rejection is probative of how Taki would have been material to the decisions of the Examiner during prosecution of the '018 Patent, had it been disclosed.

A final relevant example is U.S. Patent Application No. 14/036,514. (DX 25.) Like several of the claims in the '819 Application, claims 1-16 of the '514 Application were rejected as an attempt at double patenting in view of claims 1-20 of the '018 Patent. (Id. at 96.) The Examiner also rejected these claims as obvious in view of the combination of certain references disclosed during prosecution of the '018 Patent

(Lonberg and Kucherlapati) with three of the Withheld References (Wood, Taki, and Brüggemann). (Id. at 94.)

Regeneron amended the proposed claims in the '514 Application. One of the amendments added an additional limitation of “operably linked” in claims 17 and 19 of the application, requiring that the heavy chain variable gene region segments be “operably linked to a mouse heavy chain constant region gene at an endogenous mouse heavy chain immunoglobulin locus.” (Id. at 478.) Based on the addition of the “operably linked” limitation, these claims were then allowed. (Id. at 498.) Notably, claims 1-5 of the '018 Patent do not contain an “operably linked” limitation.

Regeneron has filed a number of additional patent applications which are continuations of the '976 Application. (See DX 26; DX 27; DX 32; DX 33; DX 19; DX 34.) The prosecution histories of these applications contain issues similar to those described above.⁴² The events in the prosecution of those applications are material to consideration of the claims of the '018 Patent. The Court finds those events, which include negative actions by the PTO in light of the Withheld References, to be probative of those references' but-for materiality.

B. European Patent '287

European Patent 1,360,287 B1 (“EP '287”) is the European counterpart to the '018 Patent. A Regeneron press release refers to them as “similar” and that they both have “claims covering genetically modified mice that have unrearranged

⁴² For instance, claims of U.S. Patent Application No. 14,046,291 were rejected over Wood. (Davis Tr. Decl. ¶¶ 188-91.)

human variable immunoglobulin variable region gene segments at endogenous mouse immunoglobulin loci." (DX 180.) Dr. Davis testified credibly that one skilled in the art would understand the claims in EP '287 to be materially similar to those in the '018 Patent. (Davis Tr. Decl. ¶ 239.)

In June 2013, pursuant to procedures allowed in Europe, Merus filed an Opposition against EP '287. (DX 64.) A hearing was held on September 16 and 17, 2014. (DX 65.) The Taki reference was specifically included as part of the argument against patentability. Following that hearing, the Opposition Division of the European Patent Office revoked EP '287 in its entirety. (DX 69 at sheets 2, 8-9.) Referring to Taki, the Opposition Division stated:

[Regeneron] argues that D4 does not provide the skilled person with the motivation to use in situ replacement but merely discloses the use of a transgene. D4 teaches on pages 74-76 the inactivation of the endogenous mouse immunoglobulin loci by homologous recombination. Therefore starting from D4 [Lonberg] the skilled person would be motivated to insert the hybrid locus and to inactivate the endogenous locus by homologous recombination. D7 [Taki] teaches the simultaneous integration of a transgene and the inactivation of the endogenous immunoglobulin heavy chain locus by homologous recombination. D7 [Taki] further teaches that targeting the transgene in the endogenous locus has the advantage of a proper regulation of the locus (see D7 [Taki], page 1268, first column). (Id. at sheet 22; ECF No. 241 ¶¶ 148, 150.)

C. Knowledge

The evidence establishes that Dr. Smeland knew of the Withheld References and the European Opposition Briefs during prosecution of the '018 Patent. (See DX 16; DX 17; DX 23; DX 64; DX 65; DX 178 at p. 2; DX 179 at p. 7; DX 840, Smeland Dep. Tr. at 265:25-266:5; DX 349.) Dr. Murphy had knowledge of at least Zou and

Brüggemann prior to the issuance of the '018 Patent. (DX 178, Regeneron's Third Supp. Response to the Court's Interrogs. 1 and 2.)

IX. MISCONDUCT

A. Patent Prosecution Misconduct

Merus alleges that Regeneron committed affirmative egregious misconduct in connection with prosecution of the '018 Patent. This conduct included (1) statements in the specification disproven by Regeneron's own subsequent patent applications (Davis Tr. Decl. ¶¶ 257-72); (2) the specification making inaccurate or incomplete statements with regard to the use of LTVEC's (Id. ¶¶ 273-87); and (3) a presentation to the PTO which contained statements that Regeneron knew at the time to be false. The Court agrees.

1. Representations regarding probing

The specification describes not only targeted insertion but also a method to probe to locate and confirm such insertion. The specification describes this portion of the invention as "An analysis to determine the rare eukaryotic cells in which the targeted allele has been modified as desired, involving an assay for modification of allele (MOA) of the parental allele that does not require sequence information outside of the targeting sequence, such as, for example, quantitative PCR." ('018 Patent, 3:21-26.) Various embodiments include using a quantitative assay to detect modifications of allele (MOA) in the eukaryotic cells (see, e.g., id., 3:36-38, 4:24-28, 4:58-60), or "a method wherein the quantitative assay comprises quantitative PCR ..." (Id., 3:53-54.) Figures 3A-D of the Patent are tables of numbers described as

“Sequence of the mouse OCR10 cDNA (upper strand, SEQ ID NO:5), homology box 1 (hb1), homology box 2 (hb2), and TAQMAN probes and primers used in a quantitative PCR assay to detect modification of allele (MOA) in ES cells ...” (Id., 8:19-23.)

The specification specifically states that the assay “does not require sequence information outside of the targeting sequence” (id., 3:24-25) and that “it is not necessary to know the complete sequence and gene structure of a gene(s) of interest to apply the method of the subject invention to produce LTVECs” (id., 11:22-25) and finally that “[e]ukaryotic cells that have been successfully modified by targeting the LTVEC into the locus of interest can be identified using a variety of approaches that can detect modification of allele within the locus of interest and that do not depend on assays spanning the entire homology arm or arms.” (Id., 13:65-14:2.)

Dr. Davis persuasively opines that these statements create the inaccurate impression that to probe for a modification, a scientist need not know the sequence of the mouse Ig loci, but need only probe the sequence targeted, and that this was incorrect. (Davis Tr. Decl. ¶ 259.) The evidence as amassed and described by Dr. Davis clearly demonstrates that to confirm an appropriate targeting, one would need to know the full sequence of the mouse Ig loci and probe not just the region targeted but the flanking region (the integrated DNA and the regions flanking the integrated DNA); Regeneron did not possess this information when it filed the application in February 2001. (Id. ¶¶ 260-72.) Internal documents reveal that the

probing strategy discussed in the specifications was first carried out after February 16, 2001. (Id. ¶ 264.)

In addition, a complete sequence of the locus is necessary because certain regions, including the mouse Ig heavy chain, are repetitive; one cannot probe for a loss of allele and be certain that the result obtained is accurate. (Davis Tr. Decl. ¶ 265.) Another internal Regeneron presentation from 2002 identifies as one of the “challenges” the fact that the “locus is more complex (repetitive) than any other targeted by VelociGene . . .” and “LOA/TaqMan Screening – additional probes required due to locus complexity.” (Davis Tr. Decl. ¶ 267, DX 165.)

2. ‘018 Patent’s LTVEC description

Dr. Davis persuasively opines that the specification’s statements regarding the use of LTVECs is incomplete and/or inaccurate. (Davis Tr. Decl. ¶ 273.) The evidence suggests that Regeneron lacked the necessary DNA sequence information to construct a targeting vector with the 5’. As stated elsewhere in this Opinion, Regeneron did not know the 5’ end of the mouse Ig locus in 2001. (Id. ¶¶ 274-75; DX 71; DX 94.) But the specification of the ‘018 Patent nonetheless described a LTVEC in which a homology arm was the 5’. (DX 337, Murphy Dep. Tr. at 200:20-201:22; ‘018 Patent 22:32-45.)

Moreover, the evidence demonstrates that as of February 2001 Regeneron could not, in fact, accomplish the very large insertions described by the ‘018 Specification. (Davis Tr. Decl. ¶¶ 285-87.) In a 2003 presentation, Dr. Murphy informed the Regeneron board that manipulation of the large loci required

development of proprietary technology. (DX 161.) That statement is contrary to the representations to the PTO in a presentation in January 2013 that the VelocImmune mouse is “made” by the claimed methods. (DX 002.)⁴³ “Proprietary technology” is not disclosed technology; the disclosures in the specifications of the ‘018 Patent were, therefore, insufficient to practice the invention. Without access to the proprietary technology referred to in this presentation one skilled in the art could not have manipulated the large loci.

3. Presentation to the PTO

Merus’s third point on affirmative egregious misconduct is that a January 2013 presentation, authored by Dr. Murphy and provided to the PTO by Dr. Smeland, had several false statements. The Court agrees; this is a finding of fact. The presentation at issue is that discussed earlier in this Opinion in connection with the prosecution history of the ‘018 Patent. In the presentation to the PTO, Regeneron made the following statements:

1. The mouse disclosed in the ‘018 Patent was the VelocImmune mouse “[c]reated only by virtue of VelociGene and VelociMouse technologies.” (DX 2 at 215.)
2. The “[p]recisely humanized Ig genes in the [VelocImmune] mouse function more efficiently than previous platforms.” (Id. at 215.)

⁴³ Dr. Oettinger responds to each of Dr. Davis’s points here – but her counterarguments are unpersuasive. For instance, her response to the need for a complete sequence is that one only needs some of the sequence to detect a modification. This ignores, however, that the detection here is focused on the insertion. To detect the insertion as discussed in the Patent, Dr. Davis has persuasively opined, the complete sequence is necessary. (Davis Tr. Decl. ¶¶ 291-92.) Use of the MOA assay as instructed by the Patent only works with sequence information of the targeted region of the host.

3. The “VelocImmune Solution” indicates that Regeneron had in fact replaced 3 Mb of the endogenous mouse IgH locus I with 150 kb of human genes in a single step. (Id. at 224.)

4. A list of characteristics of the VelocImmune mouse are compared to a “normal mouse”: normal somatic hypermutation, normal serum levels for all Ig isotypes, normal kappa:lambda light chain ratios, etc. (Id. at 227.)

5. The VelocImmune mice display “normal B cell populations in the spleen and lymph nodes” and show “normal B cell differentiation.” (Id. at 228-29.)

The evidence is overwhelming that at the time the ‘176 Application was filed, there was no VelocImmune mouse and these results did not exist. But worse, some of the results referenced in the presentation could not have existed. (Davis Tr. Decl. ¶¶ 307-30.) For instance, as of February 2001 and for a number of years thereafter, Regeneron lacked information concerning the size, composition, and regulatory elements associated with the endogenous mouse loci. (DX 145 at pp. 10055692-94; DX 166 at p. 804; DX 160 p. 241; DX 161 at p. 70; DX 37 at 9174-84.)

The lack of capability to make the necessary large DNA vectors with large homology arms frustrated enablement. (PX 835, Murphy Dep. Tr. at 141:17-22.) Dr. Murphy acknowledged that his team went a year believing that they had target locations for the proximal and distal regions of the locus, but that they had been wrong. (Id. at 158:3-10.) Despite this, Dr. Smeland argued to the Examiner that an embodiment of the claims – the VelocImmune mouse – was superior to the prior art.

At the March 11, 2013 meeting with the PTO, Dr. Jones, supervised by Dr. Smeland who had retained him and was present, told the Examiner that the VelocImmune mouse was the embodiment of the claimed invention, and was “only

possible through VelociGene technology.” (PX 840, Smeland Dep. Tr. at 232:14-233:15.) The emphasis and focus at this meeting, according to Dr. Smeland, was expressing Regeneron’s view that the Examiner’s prior rejections of the claims in the ‘176 Application, which had been based in part on Lonberg, were incorrect because Lonberg taught random rather than targeted insertion. (Id. at 246:6-13.) But Dr. Davis persuasively establishes that while this feature may have distinguished the ‘176 Application from Lonberg, it did not distinguish it from the prior art contained in the Withheld References, which a person skilled in the art would have understood to provide the motivation and instructions for the relevant insertion. (Davis Tr. Decl. ¶¶ 385-88.)

In addition to the clear evidence that the VelocImmune mouse did not exist at the time of the filing of the ‘176 Application, the description of its characteristics once it did exist was misleading. Dr. Davis persuasively explains that one familiar in the art and aware of Taki and Zou would not find the VelocImmune mouse’s comparability to a “normal mouse” on a number of criteria at all unexpected. (Davis Tr. Decl. ¶¶ 347-53.)

The Court finds by clear and convincing evidence, and without need for application of an adverse inference, that Regeneron made false and misleading statements. The Court finds by clear and convincing evidence that this constitutes egregious affirmative misconduct.

B. Discovery and Trial Misconduct

1. Claim Construction

From the outset, this Court has been concerned about Regeneron's litigation tactics. Early on, when the Court's Individual Patent Rules required that Regeneron disclose to Merus its infringement contentions, broken down by element, (See Indiv. Patent Rules 1(a)(iii).) Regeneron claimed that it could not comply. Instead, Regeneron provided a chart with infringement contentions that listed each claim as consisting of a single limitation – that is, a single element. Merus moved to compel – seeking real infringement contentions. (See ECF No. 76.) In that same motion, Merus also moved to compel production of documents as required by the Court's rules relating to the conception and reduction to practice of the '018 Patent. Regeneron claimed to have very few such documents and did not include in its production a key document written by Dr. Murphy, one of the inventors, setting forth the '018 Patent's conception and reduction to practice. (DX 145.)⁴⁴

The Court issued a written decision in response to Merus's motion to compel Regeneron to detail its infringement contention. (ECF No. 82.) At a subsequent conference, the Court discussed its concerns with Regeneron's conduct and gave Regeneron an opportunity to correct it. Regeneron chose not to. In both its order and at that conference, the Court noted that the infringement claim that Regeneron

⁴⁴ This document – which, as to certain facts such as enablement and location of the 5', one could reasonably call a "smoking gun" – was not among those initially produced. Only when Merus later learned of the document's existence did Merus move to compel its production, a motion the Court granted. (ECF No. 182.)

had asserted – as with all infringement claims – required an element-by-element identity between the accused product and the ‘018 Patent. See Abbott Labs. v. Sandoz, Inc., 566 F.3d 1282, 1296 (Fed. Cir. 2009). The Court stated explicitly, both in its written decision on this issue and at a hearing held soon thereafter, that it was troubled by Regeneron’s refusal. At that time, experienced patent counsel (subsequently replaced by Regeneron’s trial counsel here) asserted that he did not understand what the Court was asking for or how to break a claim down into elements. This made no sense and was clearly a tactical choice – seeking to shift the plaintiff’s burden in an infringement case to define the elements of a claim to the defendant, maintaining maneuvering room as a result. In retrospect, the reasons for this choice have become clear: an element-by-element breakdown of the claim eliminates the host of additional, non-claim specific limitations that are necessary for Regeneron to prevail.

The shenanigans continued.

During claim construction, Regeneron again chose tactics over substance. As the plaintiff, the Court’s rules required that Regeneron propose its claim constructions, then that the defendant respond. (See Indiv. Patent Rule 2(a)(i), 2(c)(i).) Regeneron took the position that no terms required construction. The Court issued an order (ECF No. 81) expressing its concern that Regeneron was attempting to “game” the system by shifting the burden to Merus to propose constructions and then to take shots at those proposals. The Court required Regeneron to live by its plain language constructions. (The short-sightedness of

Regeneron's position is all the more clear in light of the extensive constructions offered by Dr. Oettinger.)

Questionable conduct continued.

2. The Jones Memo

Although the conduct relating to what is referred to as the "Jones Memo" is not the primary basis for the Court's instant decision to impose sanctions, is worth reviewing for multiple reasons. First, it follows the pattern of misconduct the Court has already described. Second, Regeneron has sought to use it as a cloak for the misconduct that is the primary bases for the Court's sanctions decision: the broad waivers effectuated by the Smeland declaration and the host of discovery issues revealed by the Court's ensuing review of Regeneron's privilege log. When, as discussed below, Regeneron broadly waived the privilege in the Smeland trial affidavit but argued it was justified in nonetheless maintaining its privilege as to numerous documents on the same topics on its privilege log, its confusing defense was that, as it had complied with the Court's waiver order regarding the Jones Memo, an entirely different issue, it had no obligation to make such disclosure. The Court still cannot understand how an order on waiver as to one situation could provide any reasonable basis for failure to disclose in another.⁴⁵

The Jones Memo issue developed as follows. Discovery was in process and depositions ongoing. On the eve of Dr. Jones's deposition, Regeneron made a tactical decision to disclose a helpful chart and memorandum Dr. Jones had

⁴⁵ Much of the Court's discussion on the Jones Memo issue is also set forth in other orders. (ECF Nos. 223, 272.) The Court includes this summary for convenience.

prepared in connection with his review of whether to disclose the Withheld References during patent prosecution. These materials had previously been listed on Regeneron's privilege log on the basis of attorney-client privilege.⁴⁶

Merus asserted a broad privilege waiver and brought a motion to compel. (ECF No. 203.)

The evidence presented to the Court on that motion demonstrated that on November 7, 2013, Dr. Jones had attached the chart to an email to Dr. Smeland, and wrote, "While we discussed this analysis in numerous calls, I don't know if I have ever sent you this document. For your records, I have also attached a memo I drafted regarding the third-party disclosures made in the other U.S. case." (ECF No. 223.) That email was forwarded to Regeneron's then outside counsel on the same day. On November 11, 2014, Regeneron's outside counsel wrote an email to Regeneron stating, "I believe Brendan also discussed his analysis with Tor around the time that Brendan prepared these memos." That same e-mail notes that Dr. Jones "was asked to analyze [] whether certain references that came up in the European Opposition and the Third Party Submission should be disclosed to the PTO", and that "[t]here are several documents that he prepared on this subject in late June 2013."

In fact, the memorandum, written by Dr. Jones on June 28, 2013, appeared in all respects to be formatted and have the content of a legal memo to Regeneron – though it is designated as a memo to file. Printed on Foley Hoag letterhead and

⁴⁶ As described above, Dr. Jones was the outside patent attorney retained to represent Regeneron in the final stages of prosecution of what became the '018 Patent.

beginning with entry lines for “to”, “cc”, “from” and “regarding”, the memo read “Privileged and Confidential,” began with a summary section, contains footnotes, and is organized under formal headings. It described basic standards for the duty to disclose prior art, and analyzes the materiality of three publications. The memo amounted to an elucidation of the rationale underlying the charts and is inextricably connected to the charts. The document was plainly one created in connection with Dr. Jones’s provision of legal advice to Regeneron.

The references to discussions of the chart and analysis made clear that Dr. Jones analyzed the prior art and arrived at a legal conclusion regarding a disclosure obligation as part of his advisory role to Regeneron. He contemporaneously communicated the substance of the very same advice to his client. The Court found that Regeneron’s argument in opposition to the motion to compel – that the documents were not privileged because Dr. Jones had merely used them to assist himself in connection with some professional obligation unrelated to his advisory role to Regeneron – was “seriously incorrect.” (ECF No. 223 at 7.)

As part of its inquiry into this waiver – now called the Jones Memo issue – and particularly for the purpose of understanding what the universe of documents were that would be implicated by such waiver, the Court requested that Regeneron provide it with “[a]ll documents relating to groups or individuals who at the time of creation or subsequently thereto received a copy of the chart or memo” and “[a]ll documents and communications ... referring or relating in any way to Dr. Jones’s chart and memo.” (ECF No. 214 (emphasis added).) The Court sought these

documents for its in camera review and anticipated that all documents discussing the materiality or cumulativeness of the Withheld References that had been withheld on the basis of privilege would be included in any such production.

Regeneron subsequently provided a single binder to the Court containing what it represented constituted the universe of such materials (subject to an explicit disclosure as to that which it had held back, which related solely to certain specified litigation materials). (ECF No. 223 at n.2.) The Court was thus led to believe that it had before it all of the documents that related “in any way” to Dr. Jones’s chart and memo. As it has turned out, this was not the case. Regeneron had not in fact provided the Court with the entire universe, but had sua sponte imposed its own limitation that required any documents be directly related to the chart and memo – not “in any way” related, as the Court’s order required. Thus, the Court’s intention to include all documents concerning the subject matter was circumscribed – and appears to have included only documents directly and explicitly related to the chart and memo themselves. The Court believed the binder provided insight into all that was at issue; but the Court was in a dark room and mistook the leg of an elephant for a pillar. The Court ruled on the motion.

Because Regeneron affirmatively produced these two documents to Merus prior to a deposition, believing they were helpful,⁴⁷ it waived the attorney-client

⁴⁷ On November 12, 2014, David Gindler, then Regeneron’s outside counsel, recommended disclosing the particular documents as they “provide a helpful and concise contemporaneous summary” and a “thoughtful overview of all the prior art.” (ECF No. 223 at 9.)

privilege with regards to the same subject matter.⁴⁸ The Court found that this presented a classic “sword and a shield” issue. See In re Grand Jury Proceedings, 219 F.3d 175, 182 (2d Cir. 2000); United States v. Bilzerian, 926 F.2d 1285, 1292 (2d Cir. 1991). The Court ordered that “Regeneron and Foley Hoag [] produce to Merus all relevant documents concerning the decision to not disclose prior art during the patent prosecution.” (ECF No. 223 at 9.) The Court assumed that this covered the universe and that the universe was thus contained in the binder. Only Regeneron knew what in fact existed.

In retrospect, given this internal line drawing that only Regeneron understood, it should have come as no surprise that there was a dispute as to the scope of the waiver. The Court approached the dispute based on its experience on

⁴⁸ A party may not use the attorney-client privilege as both a “sword and a shield”. See United States v. Bilzerian, 926 F.2d 1285, 1292 (2d Cir. 1991); In re von Bulow, 828 F.2d 94, 103 (2d Cir. 1987). “In other words, a party cannot partially disclose privileged communications or affirmatively rely on privileged communications to support its claim or defense and then shield the underlying communications from scrutiny by the opposing party.” In re Grand Jury Proceedings, 219 F.3d 175, 182 (2d Cir. 2000); see also Bowne of New York City, Inc. v. AmBase Corp., 150 F.R.D. 465, 474 (2d Cir. 1993) (the privilege can be waived when the “privilege holder releases only communications or portions of communications favorable to his litigating position, while withholding any unfavorable ones”); Bilzerian, 926 F.2d at 1292 (there is an implied waiver of the privilege when a party “asserts a claim that in fairness requires examination of protected communications”). Courts make determinations of waiver on a case-by-case basis, taking into account, inter alia, whether a party’s disclosure was demonstrably prejudicial to the other party. In re Grand Jury Proceedings, 219 F.3d at 183. The Supreme Court has noted that “[p]arties may forfeit a privilege by exposing privileged evidence, but do not forfeit one merely by taking a position that the evidence might contradict.” United States v. Salerno, 505 U.S. 317, 323 (1992).

Waiver of the privilege “allows the attacking party to reach all privileged conversations regarding a particular subject once one privileged conversation on that topic has been disclosed.” In re von Bulow, 828 F.2d at 102-03; see also United States v. Jacobs, 117 F.3d 82, 89-90 (2d Cir. 1997) (petitioners waived attorney-client privilege to a document where they disclosed the substance of the opinion at issue while withholding the actual document), abrogated on other grounds by Loughrin v. United States, 134 S.Ct. 2384 (2014). However, the attacking party should not reach beyond those matters that were actually revealed where “disclosures of privileged information are made extrajudicially and without prejudice to the opposing party.” In re von Bulow, 828 F.3d at 103 (dealing with the publication of a tell-all book about the high-profile defense of Claus von Bulow).

the prior motion and in light of the binder of privileged documents previously provided. Regeneron represented that it had produced:

all documents and communications related to any decision, analysis or advice by Dr. Jones or anyone at Regeneron on whether or not to disclose references from Dr. Jones' charts and memo during prosecution of the '018 patent. In searching for this information, Regeneron: searched documents from Messrs./Drs. Pobursky, Kang, Gregg, Yang, Smeland, Yancopoulos, Sheasby, Murphy, Stevens, MacDonald, Karow, Valenzuela, and Economides... (ECF No. 262, Exh. 12.)

Regeneron also asserted broadly that it had produced all of its communications or attachments thereto from the time period of the prosecution of the '018 Patent "that even mentioned the content of any of the references cited" in the chart and memo. (ECF No. 261, pp. 7-8 (first emphasis in original, second emphasis added).)

Regeneron argued against Merus's request to impose sanction for non-compliance with the Court's order by stating that it had explained to Merus that its production was tailored to the subject matter of the Jones documents. Regeneron also argued that broader disclosure could result in serious prejudice as it could impact a pending appeal it had for EP '287, which was then in the midst of being briefed. (ECF No. 261, p. 8.)

At that time, the Court viewed the issue as a good-faith dispute over the scope of the Court's December 5 Order and read Regeneron's representations as statements that any references in any of its privileged documents to the Withheld References during the appropriate timeframe had been produced. As subject matter waiver seeks to readjust the essential unfairness in disclosing part, but not all, of an attorney-client communication, see In re Claus von Bulow, 828 F.2d 94, 101, 102-

03 (2d Cir. 1987), the required remedy should be addressed to that particular unfairness. See In re Grand Jury Proceedings, 219 F.3d 175, 182 (2d Cir. 2000).

In terms of scope, and of course based on what the Court believed was the universe of documents at issue, the Court sought to determine what – in fairness – Merus needed to receive to avoid the sword/shield issue. The Court determined that fairness required Regeneron to produce any documents which reflected additional thoughts, concerns and considerations given to whether certain references should have been disclosed. Put another way, if it turned out that there were other memos or communications related to the prosecution of the '018 Patent which stated that such references should be disclosed to the PTO, those memos or communications would have to be produced. Included within this would be drafts of Dr. Jones's chart or memo which might have contained a different conclusion, memos of others who questioned Dr. Jones's conclusion, and the like.

The Court found that the Order did not encompass the entirety of all things which Regeneron had an obligation to disclose to the PTO generally, nor did it extend to Regeneron's analysis of draft claim language. It also did not necessarily extend as far as requiring all consideration of all disclosures for other patents, even in the same family. The Court required Regeneron to confirm to Merus that it had produced or would produce:

1. All documents from anyone involved directly or indirectly in prosecuting the '018 Patent, relating to whether prior art should be or should have been disclosed as part of the prosecution of the '018 Patent....

2. To avoid any doubt, the following documents are included within the scope of the above directive:
 - a. All documents of any kind from the files of Dr. Jones and others with whom he worked on the prosecution of the '018 Patent regarding whether or not to disclose prior art to the PTO.
 - b. All documents of any kind from the files of anyone else who was involved (directly or indirectly) in the prosecution of the '018 Patent and who may not be captured in paragraph 1 above, who gave consideration to the relevance or applicability of prior art to the '018 Patent. (ECF No. 272, pp. 6-7 (emphasis added).)

Regeneron confirmed it had produced what was required.

3. The Smeland Trial Affidavit

These events lead us up to trial. A bench trial on Merus's claim of inequitable conduct was scheduled to commence on June 8, 2015. On May 29, 2015, and in compliance with this Court's rules which require a party's witnesses to testify by declaration/affidavit on direct (subject to live cross-examination and re-direct), Regeneron submitted trial affidavits from Drs. Smeland and Jones, both attorneys acting as attorneys. At this time, Regeneron's privilege log indicated that it had withheld many documents from Dr. Smeland's files and that he had authored or received on the basis of the attorney/client privilege and/or work product doctrine. The same was true with regard to Dr. Jones except as to those which Regeneron had earlier produced following the motion practice described above.

Merus cried foul. It argued that Regeneron was again engaging in a sword/shield use of the attorney client privilege and moved to strike these affidavits based on, inter alia, the assertion that Regeneron had shielded privileged documents from disclosure that were now directly implicated by the trial declarations. According to Merus, the Jones Trial Affidavit relies heavily on

information that Regeneron failed to disclose during fact discovery and in response to the Court's prior waiver order. In particular, Merus cited Dr. Jones's deposition testimony that apart from a phone call that he had made to the PTO to schedule a meeting, he could not recall a single other communication with the Examiner during the '018 Patent prosecution. Late-produced billing records were now referenced in Dr. Jones's trial affidavit. The issue was, if anything, far worse with regard to Dr. Smeland. With regard to Dr. Smeland, Merus argued that he was now proposing to testify as to his views regarding the meaning of claim language and broadly regarding his subjective understanding of the meaning of various aspects of the Withheld References, when Regeneron had withheld from its production numerous documents on those topics on the basis of privilege.

The Court reviewed each of the trial affidavits. The Court agreed that a comparison of these affidavits with entries on Regeneron's privilege logs raised a number of concerns. In his affidavit, Dr. Smeland made dozens of assertions regarding his understanding of the scope of the invention in the '176 application, his state of mind, and what he knew and thought about each of the Withheld References at the time of patent prosecution continuing up to "today." While the Court will not recite all of his assertions in this regard, a lengthy list is appropriate given the seriousness of the issue and to demonstrate obvious breadth of the waiver⁴⁹:

⁴⁹ The Court's references are to the "revised" Affidavit for Dr. Smeland. On June 4, 2015, after waiving privilege with the submission of the declarations on May 29, 2015, Regeneron sought to voluntarily withdraw portions of the Smeland declaration. At that point, Regeneron could not put the genie back in the bottle. In any event, efforts to withdraw selected portions of the declaration did

- “I firmly believed – and still believe today – that Brüggemann, Taki, Zou and Wood were not material to patentability because they were substantially different from the mice claimed in the ‘176 application ... and were cumulative of other information before the Patent Examiner.” (Smeland Aff. ¶ 4 (emphasis added).)
- “I considered the statements made in the Merus and Kymab Oppositions as attorney argument and not material to patentability.” (Id. (emphasis added).)
- “I believed—and still believe today—that the statements I made and the information that I provided to the Patent Office were not false and were not misrepresentations.” (Id. (emphasis added).)
- He was responsible for prosecution of the ‘473 Patent Application and its “claims were directed to specific steps of making modifications to genes within organisms, but were not directed to a mouse with a human variable region inserted at its endogenous mouse immunoglobulin locus (i.e., a reverse chimeric mouse) in its germline as were later prosecuted in the ‘176 application.” (Id. ¶ 23)
- He has an extensive discussion of his actions and bases for those actions in connection with prosecution of the ‘473 Application (Id. ¶¶ 24-29). He stated, “[i]t was my view that an ordinary skilled artisan would not have understood that Brüggemann, in combination with other art, taught or disclosed the pending claims in the ‘473 application.” (Id. ¶ 25 (emphasis added).)
- He states further, “[g]iven my responsibilities with preparing, filing, and prosecuting applications that are part of the 780 docket [the family of patents related to the ‘018], I gained an extensive and in-depth understanding of the prior art and Regeneron’s inventions.” (Id. ¶ 35.)
- With regard to the ‘018 Patent, he states, “[a]s I understood the claim during prosecution of the ‘176 application, it encompasses

not change the fact that Smeland’s declaration remained focused on his state of mind at the time of patent prosecution. For example, Regeneron sought to strike “and still believe today” from the fourth paragraph of the Smeland declaration: “I firmly believed – and still believe today – that Brüggemann, Taki, Zou and Wood were not material to patentability . . .” The remaining portions of the declaration still implicate a broad waiver of the privilege.

a mouse with a functional reverse chimeric immunoglobulin locus in its germline DNA. ... As is clear from the specification, the reverse chimeric locus must be functional... The '018 Patent invention describes the first such mouse of which I am aware.” (Id. ¶ 37 (emphasis added).)

- “I stated this understanding of the claims in my communications with the Patent Office during prosecution of the '176 application.” (Id. ¶ 38.)
- “It was not my understanding that the ordinary skill artisan would have the view that mice of the '018 Patent claims must be made using any particular method or assays.” (Id. ¶ 39 (emphasis added).)
- “One of the advantages of the '018 Patent inventions includes the fact that mice encompassed by the claims have ‘natural’ B-cell development processes along with the ability to obtain high affinity reverse chimeric antibodies.” (Id. ¶ 40.)
- “I believed that the Examiner misunderstood Lonberg, which disclosed transgenes randomly inserted at unknown loci. ... Lonberg recognized that the rearranged variable region of a randomly inserted human segment could sometimes join to a portion of the endogenous mouse immunoglobulin, resulting in an antibody consisting of human variable and mouse constant heavy chain (although not in the germline). ... It is not possible to breed Lonberg mice so as to have reverse chimeric loci in the germline.” (Id. ¶ 46 (first emphasis added).)
- “On January 11, 2013, I amended the claims and again explained why the disclosures in Lonberg did not anticipate the claimed inventions. ... I also...pointed out that Regeneron’s VELOCIMMUNE mice, which I understood were embodiments of the claims, exhibited features that were unexpected in light of the prior art.” (Id. ¶ 49 (emphasis added).)
- “I believed that [the Examiner] was misunderstanding the science and Lonberg as well as the difference between the Lonberg reference and the claims. As a result, I decided to appeal...” (Id. ¶ 51 (emphasis added).)
- “I expected the appeals process to take a year and a half or more, but I was confident that the Examiner was

misunderstanding Lonberg and that the Board would agree.” (Id. ¶ 52 (emphasis added).)

- “I filled Dr. Jones in on the status of the ‘176 case and, after Dr. Jones was engaged, he suggested that we set up an in-person interview with the Examiner to see if Lonberg could be better explained in person prior to moving forward with an appeal.” (Id. ¶ 53.)
- “...the EP ‘287 Patent inventions related to reverse chimeric modifications...” (Id. ¶ 61.)
- In footnote 21 Dr. Smeland describes his understanding of what a materiality analysis for inequitable conduct involves: “Regardless of whether I satisfied the minimum requirements of being an ordinary skilled artisan, I felt comfortable evaluating the art from that perspective during the prosecution of the ‘176 application. When I did have questions, however, I did not hesitate to reach out to those with more experience and knowledge.” (Id. ¶ 70 n.21.)
- “I routinely made Regeneron inventors aware of the foregoing obligations when providing them with invention declarations.” (Id. ¶ 73.)
- With regard to the Withheld References, “I did not believe that the information contained in the foregoing references and oppositions was material to patentability...” (Id. ¶ 74 (emphasis added).)
- With regards to Brüggemann and Zou, “I was generally familiar with the subject matter of those two references... [a]t no time did I consider these references to be material to patentability to the claims pending in the ‘176 application.” (Id. ¶ 75 (emphasis added).)
- “Because of this experience [prosecuting the ‘176 application as well as the ‘287 Patent], I was readily familiar with both prior art that was before the Examiner in the ‘176 application and the pending claims of the ‘176 application.” (Id. ¶ 76 (emphasis added).)
- “I viewed the analysis [relating to the Withheld References] as straightforward.” (Id. ¶ 78 (emphasis added).)

- “I concluded that [the Withheld References], alone or combined with other prior art of which I was aware, were cumulative of information already before the Examiner. Furthermore, it was my view that the skilled artisan would not have viewed them as teaching the reverse chimeric inventions that the Examiner had allowed in the ‘176 application.” (Id. ¶ 79 (emphasis added).)
- Dr. Smeland stated his rationale for not filing a Request for Continued Examination. (Id. ¶ 80).
- Dr. Smeland then proceeded to make a number of detailed statements regarding his views and understanding of the technology in each of the Withheld References and comparing it to the claims in the ‘176 application. (See id. ¶¶ 83-115.) As to each, he states what he “believed” at the time, and that he continues to hold that belief “today.” (E.g., id. ¶¶ 88, 94, 102, 114.)
- Dr. Smeland then testifies as to the meaning of claim terms in the ‘018 Patent. (See id. ¶¶ 129-135.)
- With regard to the slide presentation to the PTO, he again makes a number of assertions as to why he believes each of the statements contained in that document are true; he states, “Finally, given that I understand that the presentation was prepared for internal use and I did not alter any slides, I highly doubt that those who prepare the presentation intended to mislead others at Regeneron.” (Id. ¶ 143 (emphasis added).)
- With regard to the MOA assay, he states, “[d]uring the prosecution of the ‘176 application I did not believe that the pending claims required use of any particular MOA assay.” (Id. ¶ 144 (emphasis added).)
- Dozens of pages that follow containing state of mind assertions as well.

These statements and others implicate Dr. Smeland’s knowledge and state of mind directly – both during patent prosecution and continuing to date. He is using these statements to counter Merus’s assertion that he acted in bad faith by discussing what he knew, believed, understood, communicated, etc. There is

certainly a good tactical reason to confront Merus's position with testimony from Dr. Smeland. However, that tactical choice must occur in the context of other choices made throughout the litigation – choices as to whether to waive attorney-client privilege or not. Here, Regeneron made a litigation choice to maintain the attorney-client privilege as to Dr. Smeland's work with regard to prosecution of the '176 application and his knowledge and thoughts regarding the Withheld References generally over time and specifically with regard to the prosecution of the '176 application. In maintaining its assertion of privilege on these topics, Regeneron used the protections of the Federal Rules of Civil Procedure to shield Dr. Smeland's documents relating to those topics from disclosure. This was a choice that was within Regeneron's discretion – but not a choice that allows them to have it both ways at trial. By making the choice to maintain the privilege and withhold the documents, Regeneron chose the tactical path of not delving into state of mind or knowledge to defend against the claim of inequitable conduct. And of course, given the heavy burden that a proponent of an inequitable conduct bears of proving materiality and intent by clear and convincing evidence, this was not an unreasonable choice. As with any affirmative disclosure of information otherwise protected by the attorney-client privilege, once the disclosure of the affidavit was made, as it was not inadvertent, the waiver was complete.

Thus, on the day that Regeneron disclosed Dr. Smeland's trial affidavit, it waived the privilege as to the subject matter of each of the topics the affidavit addressed. This was intentional and permanent. As described above, this included

his views on meaning and scope of claim language, understanding of the technology, materiality (including cumulateness) of each of the Withheld References. Many of his documents are to or from Dr. Murphy, while others involve Dr. Jones. And as noted below, this process revealed a host of withheld non-privileged documents. Thus, the waiver rippled throughout the case.

The problem, of course, was how this position at trial interacted with Regeneron's discovery obligations. In order to take this position at trial, Regeneron was obligated to have previously produced the documents from Dr. Smeland's files that would have allowed Merus to test his various assertions. This would have substantially altered a significant swath of discovery, including Dr. Smeland's deposition, the deposition of others with whom he interacted, expert discovery, and on. Regeneron did not fulfill its discovery obligations in this regard. That is clear both from a review of the log and the Court's in camera review of documents on the log. There are dozens of documents on Regeneron's privilege log which are from Dr. Smeland's files, and which concern these very topics.⁵⁰

The Court conducted an in camera review of the documents on the log. Regeneron was, after all, asserting it had done all it was obligated to do. Merus pointed to seemingly inconsistent entries on the log. As it turned out, the log was "Pandora's Box." The Court's in camera review revealed that Merus was certainly correct – there were dozens of "Smeland documents" as to which the privilege had now been waived. But the in camera review revealed far more. It revealed

⁵⁰ For a more extensive discussion of the documents themselves, the Court refers to the post-trial briefing of the parties on this issue, including the documents attached thereto.

additional serious discovery issues: a number of non-privileged documents related to topics at issue throughout the litigation had been withheld on the basis of privilege, and other documents that should have been produced pursuant to the order regarding the Jones Memo issue had not in fact been disclosed.

In all, there were three categories of documents that presented serious concerns of discovery misconduct:

1. Non-privileged documents that were not produced and instead have resided throughout this case on the privilege log (e.g. numerous Excel spreadsheets with scientific test results, third party filings to the PTO, fact statements by non-lawyers not seeking legal advice, etc.).
2. Previously privileged documents as to which Regeneron affirmatively waived the privilege and that this Court ordered be produced pursuant to its February 25, 2015 order. (ECF No. 272.)
3. Documents on the privilege log relating to precisely those topics waived by Regeneron on May 29, 2015 when it filed its trial declarations.

The Court determined that failure to make full and adequate production of documents in the first two categories during the period of fact discovery itself and independently of the trial misconduct warranted serious sanction. The production failure is undoubtedly larger than the few exemplars revealed by the Court's own review. Given the many thousands of documents on Regeneron's privilege log, the Court cannot know the full extent of the problem.

As to the first category, there were spreadsheets related to scientific tests, published articles, correspondence with third parties – all of which were relevant to issues in the case. The ultimate importance of the documents in this category is unclear, but that Merus should have had them long ago is not.

In the second category, there are a number of documents on the log which Dr. Jones is on discussing communication with the PTO, before and after the meeting on March 2013. These should have been produced as part of the “Jones Memo” waiver issue.

The third category of documents presents its own very serious issues. Many documents on the log are directly relevant to the topics as to which privilege has been waived. Some of those documents contain statements directly contradictory to Smeland’s sworn trial declaration.

To allow into evidence at trial declarations from witnesses to whom these three categories of documents relate could only occur – in fairness – if there was a wholesale re-opening of discovery. As a first step, a top-to-bottom re-review of the Regeneron privilege log would be necessary. This would have to be followed by additional document production, fact depositions, and revised expert reports and depositions. Given the Court’s concerns with Regeneron’s process to date, the Court would require that any such process only occur with the direct oversight of a special master. It is clear that this process and the attendant discovery would consume substantial time and cost. It would also undoubtedly require further judicial resources. At this point in the litigation, this is not a fair burden for Merus or this Court.

The Court has considered whether striking the trial affidavits and precluding Smeland and Murphy from testifying at trial would be a sufficient remedy.⁵¹ It

⁵¹ The Court bifurcated the trial. The first determination which must be made in a trial on inequitable conduct is the materiality of the information. Therasense, Inc. v. Becton, Dickinson &

would not, though such an order is a minimum starting point. Based on the considerations discussed below and as set forth in the Court's prior decision, simply striking those two declarations and precluding trial testimony from just them would not sufficiently address the many issues now in play; those issues spread broadly into the case.

First, the first two categories of documents themselves revealed a separate need for a re-review of the privilege log, production, and of course depositions as needed. Second, striking the declarations and precluding certain witnesses alone fails to remedy the substantial disruption and delay that would be caused by Regeneron's conduct. Third, merely striking the declarations and precluding certain witnesses would fail to recognize Regeneron's pattern of conduct throughout this litigation. That conduct included, inter alia, a host of issues at the outset regarding infringement contentions, positions in relation to claim construction and positions and representations with regard to the Court's February 25 Order (the Jones Memo Order). The Court also understands that current trial counsel was not responsible for the preparation of the privilege log and was not counsel at the outset of this case when the first issued occurred (though they were counsel for the Jones Memo order). In all events, this pattern by Regeneron is just that – a pattern. It is troubling to say the least. Merely striking the declarations and precluding

Co., 649 F.3d 1276, 1291 (Fed Cir. 2011) (en banc). The Court therefore bifurcated that inquiry from the second determination: Regeneron's intent. The Court's rationale was that the first topic would be addressed by the experts and through documents, and the second (which involved testimony from Drs. Smeland and Murphy) was only necessary if the Court determined the first issue in Merus's favor.

testimony treats the most recent issues as isolated and remediable – when they are yet another step in a long pattern of litigation choices that have caused delay, inefficient use of resources, and diversion from the merits.

The Court has carefully considered the appropriate combination of remedies that best – and most narrowly – addresses where we find ourselves in this litigation today. The Court includes in its analysis of appropriate remedy the history of conduct that Regeneron has engaged in to this point.

Under these highly unusual circumstances, it is appropriate to preclude the testimony of Smeland, Murphy and Jones. In recognition of the implications the discovery conduct has on the entirety of the case, it is additionally appropriate for the Court to impose the sanction of an adverse inference as to the intent of Smeland and Murphy with regard to inequitable conduct during patent prosecution. See Residential Funding Corp. v. DeGeorge Fin. Corp., 306 F.3d 99, 108-10 (2d Cir. 2002). The Court therefore infers that Drs. Smeland and Murphy together knew of each of the Withheld References, knew they were material, and made a deliberate decision to withhold them. In short, they acted with the specific intent to deceive the patent office. The Court finds that this is “the single most reasonable inference able to be drawn from the evidence”. Therasense, 649 F.3d at 1290 (quoting Star Sci., Inc. v. R.J. Reynolds Tobacco Co., 537 F.3d 1357, 1366 (Fed. Cir. 2008)); see also Residential Funding Corp. v. DeGeorge Fin. Corp., 306 F.3d 99, 108 (2d Cir. 2002) (discussing circumstances in which “[t]he sanction of an adverse inference may be appropriate”). The Court therefore finds by clear and convincing evidence

that Drs. Smeland and Murphy knew of the Withheld References, knew of their materiality, and made the deliberate decision to withhold them.

X. CONCLUSION

For the reasons set forth above, the Court finds that Regeneron has engaged in inequitable conduct in connection with prosecution of the '018 Patent.

The parties shall confer on a form of order of judgment and file either a joint proposed order or competing proposed orders within fourteen (14) days.

The Clerk of Court is directed to terminate this action.

SO ORDERED.

Dated: New York, New York
November 2, 2015

A handwritten signature in black ink, appearing to read "K. B. Forrest".

KATHERINE B. FORREST
United States District Judge