

United States Court of Appeals
for the Federal Circuit

PPC BROADBAND, INC.,
Appellant

v.

CORNING OPTICAL COMMUNICATIONS RF, LLC,
Appellee

2015-1364

Appeal from the United States Patent and Trademark
Office, Patent Trial and Appeal Board in No. IPR2013-
00342.

Decided: February 22, 2016

J. MICHAEL JAKES, Finnegan, Henderson, Farabow,
Garrett & Dunner, LLP, Washington, DC, argued for
appellant. Also represented by ROBERT L. BURNS, II,
Reston, VA; JUSTIN A. HENDRIX, Palo Alto, CA.

TODD RAY WALTERS, Buchanan Ingersoll & Rooney
P.C., Alexandria, VA, argued for appellee. Also represent-
ed by SCOTT LLOYD SMITH, ROGER HYUNGIL LEE.

Before MOORE, O'MALLEY, and WALLACH, *Circuit Judges*.

MOORE, *Circuit Judge*.

PPC Broadband, Inc. appeals from the United States Patent and Trademark Office's Patent Trial and Appeal Board's ("Board") final written decision in an inter partes review ("IPR") concluding that claims 10–25 of U.S. Patent No. 8,323,060 would have been obvious. Because we conclude that the Board erred in its construction of "reside around," we *vacate* and *remand* for further proceedings.

BACKGROUND

A coaxial cable has an inner electrical conductor (often called the "signal" or "signal feed") and an outer electrical conductor (often called the "ground return" or "ground"). Poor or intermittent connections on either conductor can result in noise or non-functionality. The '060 patent discloses coaxial cable connectors having a connector body 50, a post 40, a nut 30 (also called a "coupler"), and a "continuity member" that contacts the post and the nut so that electrical grounding continuity is extended through the post and the nut. '060 patent, Abstract. The '060 patent discloses more than twenty embodiments of continuity members. In some of these embodiments, the continuity member lays adjacent to or extends underneath the body 50. *See, e.g.*, '060 patent, figs. 13, 17.

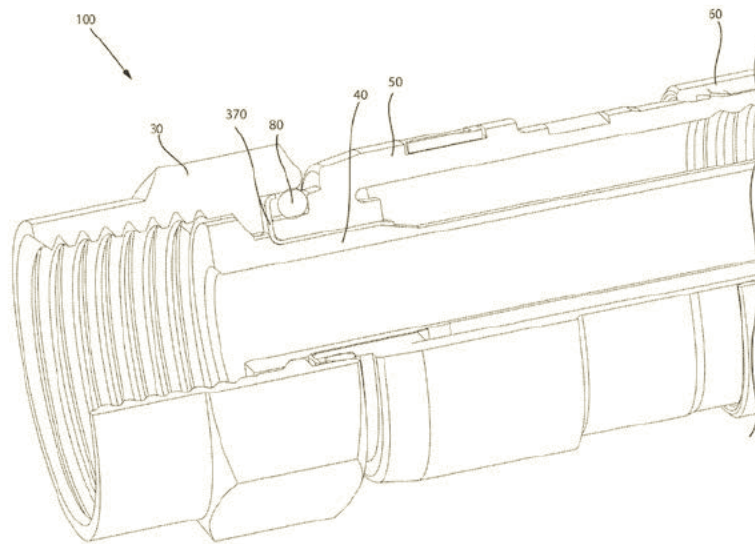

Figure 13 of the '060 patent: In this embodiment, the continuity member 370 extends underneath the body 50.

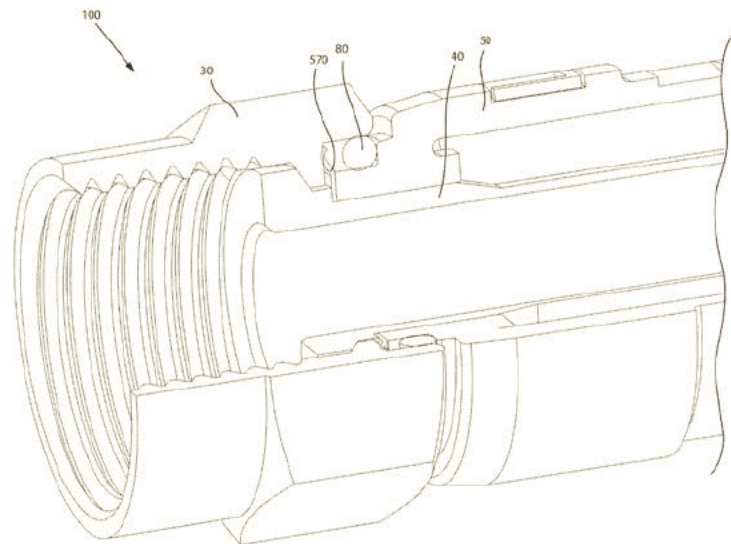

Figure 17 of the '060 patent: In this embodiment, the continuity member 570 abuts the face of the body 50.

In other embodiments, the continuity member is fitted around the body 50 in a “sleeve-like configuration.” ’060 patent, col. 14 l. 51, figs. 21–26.

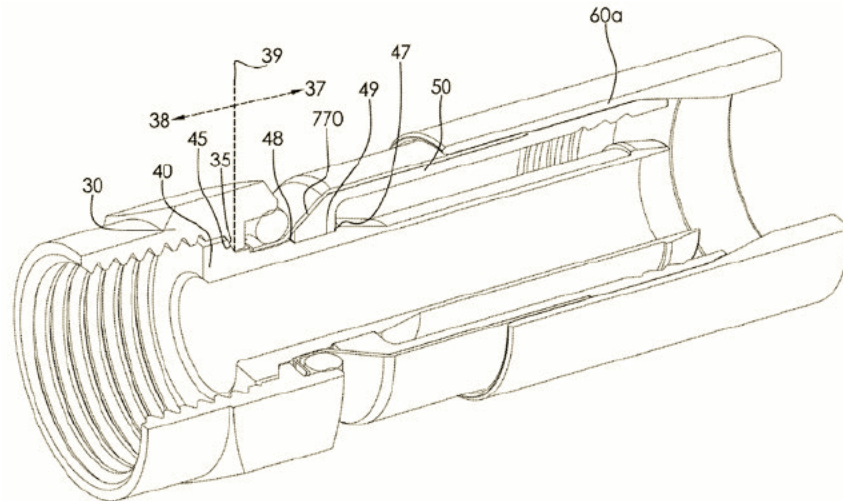

Figure 24 of the '060 patent: In this embodiment, the continuity member 770 is fitted around the body 50 in a sleeve-like configuration.

And in one of these embodiments, the continuity member connects the post and the nut without touching the body 50. ’060 patent, col. 12 ll. 21–26 & fig. 7.

Claim 10, the only independent claim on appeal, recites (emphasis added):

A coaxial cable connector for coupling an end of a coaxial cable, the coaxial cable having a center conductor surrounded by a dielectric, the dielectric being surrounded by a conductive grounding shield, the conductive grounding shield being surrounded by a protective outer jacket, the connector comprising:

...

a continuity member having a nut contact portion positioned to electrically contact the nut and *positioned to reside around an external portion of the connector body* when the connector is assembled, wherein the continuity member helps facilitate electrical grounding continuity through the body and the nut and helps extend electromagnetic shielding from the coaxial cable through the connector to help prevent RF ingress into the connector.

Corning Optical Communications RF, LLC filed a petition requesting an IPR of claims 10–25 of the '060 patent on grounds that the claims were invalid as obvious over the combination of U.S. published patent application 2006/0110977 (“Matthews”) and Japanese published patent application JP 2002-015823 (“Tatsuzuki”). On November 26, 2013, the Board instituted proceedings.¹

In the IPR proceedings, relying on a generalist dictionary, the Board construed the term “reside around” to mean “in the immediate vicinity of; near.” The Board concluded that the combination of Matthews and Tatsuzuki taught a continuity member that was positioned in the immediate vicinity of, or near, an external portion of the connector body. Having found the combination of Matthews and Tatsuzuki to teach all other limitations of claims 10–25 of the '060 patent, the Board concluded that

¹ Corning also sought, and the Board granted, IPR proceedings on claims 1–9 of the '060 patent, claims 1–32 of related U.S. Patent No. 8,287,320, and claims 7–27 of related U.S. Patent No. 8,313,353. In separate proceedings, the Board invalidated all of these claims as obvious over the combination of Matthews and Tatsuzuki. PPC Broadband also appealed these decisions to this court in Appeal Nos. 2015-1361, -1366, -1368, and -1369.

the claims at issue were obvious. PPC Broadband appeals. We have jurisdiction under 28 U.S.C. § 1295(a)(4).

DISCUSSION

We review the Board's legal decisions *de novo* and its underlying factual determinations for substantial evidence. *In re Sullivan*, 498 F.3d 1345, 1350 (Fed. Cir. 2007). Obviousness is a question of law with underlying issues of fact. *Randall Mfg. v. Rea*, 733 F.3d 1355, 1362 (Fed. Cir. 2013). In IPR proceedings, the Board gives claims their broadest reasonable interpretation consistent with the specification. *In re Cuozzo Speed Techs., LLC*, 793 F.3d 1268, 1279 (Fed. Cir. 2015), *cert. granted*, 84 U.S.L.W. 3218 (U.S. Jan. 15, 2016) (No. 15-446). We review claim construction *de novo* except for subsidiary fact findings based on extrinsic evidence, which we review for substantial evidence. *Id.* at 1280.

I. The “Reside Around” Limitation

PPC Broadband challenges the Board's construction of “reside around.” It argues that the Board's construction, “in the immediate vicinity of; near,” is unreasonably broad in light of the '060 patent's claims and specification. PPC Broadband argues that the broadest reasonable construction of “reside around” in light of the claims and specification is “encircle or surround.” PPC Broadband argues that the continuity member resides around an external portion of the connector body even if it is not completely continuous. We agree with PPC Broadband's construction, concluding that it is the broadest reasonable construction in light of the claims and specification.

The Board gives claims their broadest *reasonable* interpretation consistent with the specification. *Cuozzo*, 793 F.3d at 1279. The Board seems to have arrived at its construction by referencing the dictionaries cited by the parties and simply selecting the broadest definition therein. And it does appear that among the many defini-

tions contained in the dictionaries of record “in the immediate vicinity of; near” is the broadest. While such an approach may result in the broadest definition, it does not necessarily result in the broadest reasonable definition in light of the specification. The Board’s approach in this case fails to account for how the claims themselves and the specification inform the ordinarily skilled artisan as to precisely which ordinary definition the patentee was using.

As the Board noted, the primary and secondary definitions of the term “around” in THE AMERICAN HERITAGE COLLEGE DICTIONARY (4th ed. 2002) are “1. On all sides of: *trees around the field*. 2. In such a position as to encircle or surround: *a sash around the waist*.” J.A. 65 (citing J.A. 2966). These definitions would support PPC Broadband’s proposed construction. The fourth definition of “around” in THE AMERICAN HERITAGE COLLEGE DICTIONARY is “in the immediate vicinity of; near: *She lives around Norfolk*.” J.A. 2966. This definition would support the Board’s construction.

The fact that “around” has multiple dictionary meanings does not mean that all of these meanings are reasonable interpretations in light of this specification. And we conclude that in this context the Board’s construction is not reasonable. Claim 10 and indeed all of the claims of the ’060 patent claim coaxial cable connectors. The components of these connectors—for example, the nut, the post, the body, and the continuity member—partially or wholly encircle the inner electrical conductor. *See* ’060 patent, fig. 1. For the most part, each of these components has a geometry that is symmetrical around the inner electrical conductor. *Id.* Given the context of this technology, it seems odd to construe the term “reside around” without recognizing the context of its use in terms of the coaxial cable at issue.

To the extent that the Board reasoned that PPC Broadband's construction was at odds with other claim language, we do not agree. Claim 10 recites a continuity member that is "positioned to reside around an external portion of the connector body when the connector is assembled." The Board concluded that the use of "surrounded" in the preamble of claim 10—"the coaxial cable having a center conductor *surrounded* by a dielectric, the dielectric being *surrounded* by a conductive grounding shield, the conductive grounding shield being *surrounded* by a protective outer jacket"—indicates that the inventors of the '060 patent did not intend the word "reside around" to have the same meaning as "surrounded." J.A. 65–66. There is a canon of construction: "the general assumption is that different terms have different meanings." *Symantec Corp. v. Comput. Assoc. Int'l, Inc.*, 522 F.3d 1279, 1289 (Fed. Cir. 2008). This canon is certainly employed in both statutory interpretation and claim construction. In fact, many of the canons of statutory construction apply equally when interpreting patent claims. Thus, if the term "surrounded" was used in one claim element and "resides around" in a second claim element, it is reasonable to view the differing terms as being intended to have a different scope. None of these canons are themselves dispositive but rather exist as a tool to aid in assessing meaning. This general canon, recognizing linguistic differentiation, is "not true for terms in the preamble." *Id.* (citation omitted). The purpose of a preamble is to set forth the general nature of the invention being claimed. It is generally not used as or intended to be a limiting factor in delineating boundaries of the scope of the invention as claimed. And in this case, no party argues, and the Board did not conclude, that the preamble of claim 10 is limiting. When the preamble has this general purpose, and is not being used as a claim limitation itself, the construction canon which presumes that different terms should be given different meanings has less applicability.

When we turn to the specification of the '060 patent, it provides strong support for PPC Broadband's interpretation. Neither party disputes that the word "reside" indicates location. Instead, the parties' dispute centers on the meaning of the word "around." The specification's use of the word "around" leaves no doubt about its meaning. "Around" occurs seven times in the specification. Every one of these occurrences relates to encircling or surrounding. *See, e.g.*, '060 patent, col. 6 ll. 24–26 ("[T]he shield 14 may comprise a metal foil wrapped *around* the dielectric 16, or several conductive strands formed in a continuous braid *around* the dielectric 16." (emphases added)), col. 7 ll. 14–16 ("a body O-ring configured to fit *around* a portion of the connector body 50" (emphasis added)), col. 8 ll. 47–49 ("the post 40 may be inserted . . . *around* the dielectric 16" (emphasis added)), col. 12 ll. 26–28 ("A continuity member 70 may be positioned *around* an external surface of the post 40" (emphasis added)), col. 16 ll. 61–64 ("The flexible portions 1079*a-b* may be pseudo-coaxially curved arm members extending in yin/yang like fashion *around* the electrical continuity member 1070." (second emphasis added)), col. 20 ll. 3–6 ("A body sealing member 1280 may be positioned . . . snugly *around* the connector body 1250." (emphasis added)).

By contrast, the words "near" or "nearest" are used twelve times in the specification, each time meaning "in the vicinity of." *Id.* col. 2 l. 3, col. 2 l. 5, col. 8 l. 27, col. 9 l. 3, col. 9 l. 30, col. 9 l. 40, col. 12 l. 48, col. 12 l. 52, col. 14 l. 63, col. 15 l. 1, col. 19 l. 40, col. 19 l. 44. The specification never uses the word "around" to mean "near" or "in the vicinity of."

Corning argues that the term “around” does not mean “encircle or surround” in one of the occurrences of “around” in the specification—the “pseudo-coaxially curved arm members extending in yin/yang like fashion *around* the electrical continuity member.” ’60 patent, col. 16 ll. 61–64; *see also id.* fig. 35. Instead, it argues

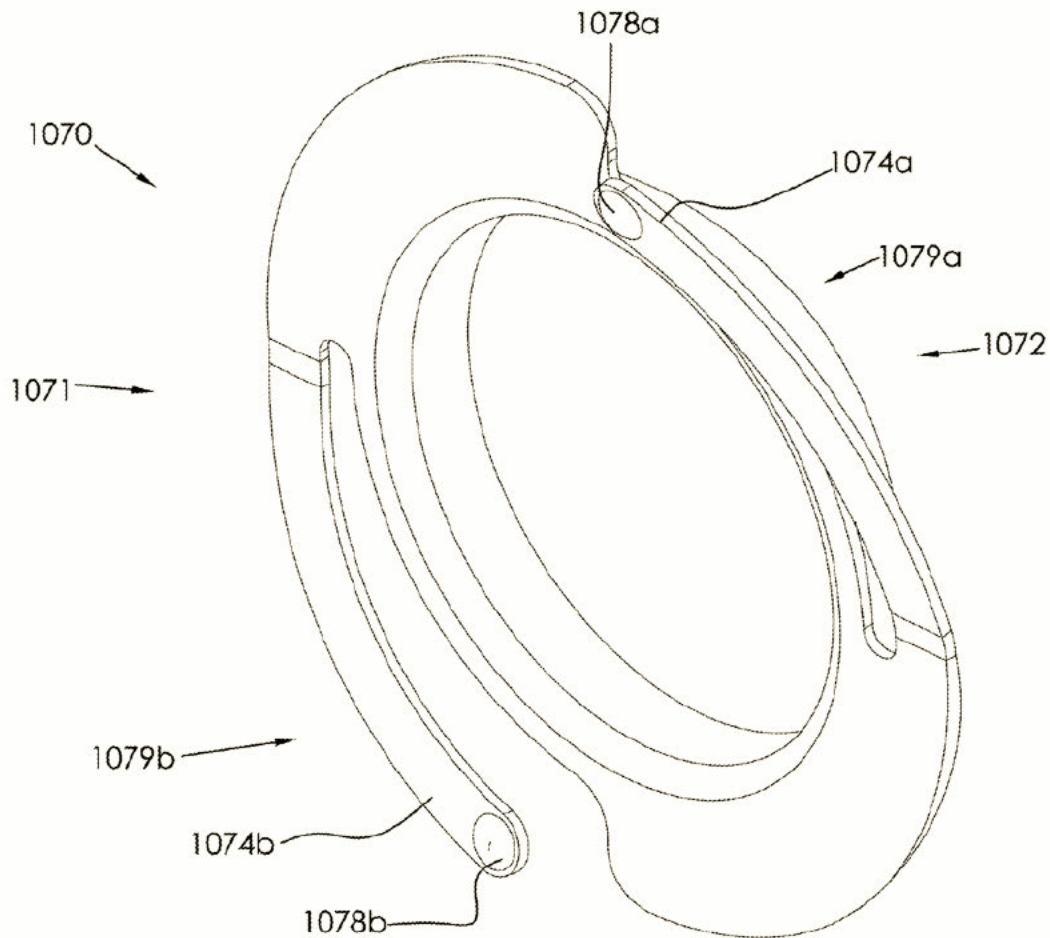

Figure 35 of '60 patent

that in this embodiment, the curved arm members extend around the continuity member only partially and in a non-planar fashion. Appellee’s Br. 25; Oral Argument at

17:39–18:12, *available* *at*
[http://oralarguments.cafc.uscourts.gov/
default.aspx?fl=2015-1364.mp3](http://oralarguments.cafc.uscourts.gov/default.aspx?fl=2015-1364.mp3). It is correct that the arm members of this embodiment extend only partway around the continuity member. But if these arm members were fully extended, they would encircle the continuity member completely, albeit at an angle. We do not think the construction “encircle or surround” requires *complete* encirclement, or encirclement in a plane perpendicular to the axis—particularly under the broadest reasonable interpretation standard. Even if PPC Broadband’s construction did require complete or near-complete encirclement, the specification teaches that in this embodiment the arms extend around the continuity member “in yin/yang like fashion.” The phrase “in yin/yang like fashion” modifies the term “extending . . . around” just as if the inventor had written that the arms extend *partially* around the continuity member. The specification uses the modifier “yin/yang like fashion” to further delineate its meaning of “around” in the context of that one embodiment.

Corning also argues that we should reject PPC Broadband’s construction because it excludes multiple embodiments disclosed in the ’060 patent. It argues that the Board’s construction, by contrast, includes all of the embodiments of the ’060 patent. Essentially, Corning argues that the broadest reasonable interpretation is the interpretation which includes as many of the disclosed embodiments as possible.

We have often remarked that a construction which excludes the preferred embodiment is “rarely, if ever correct.” *Vitronics Corp. v. Conceptoronic, Inc.*, 90 F.3d 1576, 1583 (Fed. Cir. 1996). A construction which reads the preferred embodiment out of the scope of the claims would generally seem at odds with the intention of the patentee as expressed in the specification. *See Funai Elec. Co. v. Daewoo Elecs. Corp.*, 616 F.3d 1357, 1371

(Fed. Cir. 2010) (refusing to read out preferred embodiment when patent-at-issue included only two embodiments). This does not mean, however, that each and every claim ought to be interpreted to cover each and every embodiment. *Baran v. Med. Device Techs., Inc.*, 616 F.3d 1309, 1316 (Fed. Cir. 2010) (“It is not necessary that each claim read on every embodiment.”). The ’060 patent specification has more than 50 figures and discloses more than 20 embodiments of continuity members. The specification discloses several embodiments where the continuity member encircles or surrounds the body in a “sleeve-like configuration.” ’060 patent col. 14 ll. 47–52, col. 15 ll. 33–37, figs. 21–26. And, in fact, it is in the discussion of components that encircle or surround that the specification repeatedly uses the term “around.” PPC Broadband’s construction of “reside around” as “encircle or surround” is consistent with the use of “around” in these embodiments, and construed in this manner claim 10 would cover these disclosed embodiments. It is correct that PPC Broadband’s construction would not cover all disclosed embodiments. For example, Figure 17 of the ’060 patent depicts a continuity member that does not encircle or surround the body but rather abuts the face of the body. And Figure 13 depicts a continuity member that extends underneath the body.

We will not adopt the position advocated by Corning that the broadest reasonable construction is always the one which covers the most embodiments. Above all, the broadest reasonable interpretation must be *reasonable* in light of the claims and specification. The fact that one construction may cover more embodiments than another does not categorically render that construction reasonable.²

² And though it is not dispositive, we are not certain based on this record that Corning is correct that the

The canons of construction are but tools to be used to help determine the meaning of claim terms. Our construction creates no incongruity. While there will be some embodiments that do not fall within the broadest reasonable construction of claim 10, it is clear based on the patentee's use of "around" in the specification to refer to components that encircle or surround that the broadest reasonable interpretation is limited to this use of the term. Moreover, claim 10 is certainly not the only claim in this patent. And while we will not prophetically discuss whether particular embodiments are covered by claims not at issue, Corning has not argued that PPC Broadband's construction of "reside around" would result in preferred embodiments being entirely excluded from claim coverage. We note that claim 1 does not contain the "reside around" limitation. Although claims ought to be construed such that their preferred embodiment falls within their scope, this does not require the construction adopted by the Board. This patent contains many claims of varying scope and more than twenty different disclosed embodiments. And the specification consistently uses the term "around" in a manner to indicate encircling or surrounding and applying only to components with this configuration.

Board's construction would bring all of the twenty embodiments within the coverage of claim 10. Corning itself admits that the Board's construction would not extend to a continuity member located "inside the body"—and it is not clear, and we do not need to decide, whether the continuity members depicted in Figure 5 and Figure 11 are located inside the body or in the vicinity of the external portion of the body. *See* Appellee's Br. 24; *see also* '060 patent, figs. 5 & 11 (depicting continuity members positioned underneath the body).

Given the context of the claims, the specification, and the technology of the '060 patent, we conclude that the Board's construction of "reside around" is unreasonable. The broadest reasonable interpretation of the term "reside around" in light of the claims and specification is "encircle or surround." We agree with PPC Broadband that the '060 patent indicates that such encirclement need not be absolute.

This is a close and difficult case because of the standard that the Board uses to construe claims. The Board applies the broadest reasonable construction standard even in IPRs which are litigation-like contested proceedings before the Board. The Board uses this standard even when the identical patent may be simultaneously in litigation involving the identical parties and where the district court would be deciding the correct construction consistent with *Phillips v. AWH Corp.*, 415 F.3d 1303 (Fed. Cir. 2005) (en banc). Thus, it is possible to have two different forums construing the same term in the same patent in a dispute involving the same parties but using different standards. If we were tasked with reviewing the Board's construction according to *Phillips*, and in fact if the Board had applied the *Phillips* standard rather than the broadest reasonable construction, this case would be straight-forward. PPC Broadband's construction is the only construction of the term consistent with the use of the same term throughout the specification. But this case is much closer under the broadest reasonable interpretation standard given the ordinary meanings attributable to the term at issue. We conclude that while close, the Board's construction is not reasonable in light of the specification. Given our conclusion, the Supreme Court's grant of certiorari to consider the propriety of the broadest reasonable interpretation in IPRs will not affect the outcome of this case. *Cuozzo*, 793 F.3d 1268, *cert. granted*, 84 U.S.L.W. 3218.

II. The “Axially Lengthwise Contact” Limitation

PPC Broadband also challenges the Board’s determination that the Tatsuzuki spring met claim 13’s “axially lengthwise contact” limitation. Dependent claim 13 of the ’060 patent recites that the continuity member “is configured to make axially lengthwise contact with the post at a position axially rearward of the external annular protrusion.” In construing the term “axially lengthwise contact,” the Board adopted PPC Broadband’s proposed construction of “contact that is in the direction of, on, or along an axis that includes at least some length.” J.A. 81. The Board further explained that “because lengthwise contact includes at least some length, it precludes point contact.” J.A. 81. The Board found that Tatsuzuki’s “thin metal plate” met this limitation, reasoning that it provided more than point contact “[r]egardless of how thin” it was. J.A. 82–83.

PPC Broadband does not dispute the Board’s construction of the “axially lengthwise contact” limitation; instead, it argues that the Board erred in finding that the Tatsuzuki spring met this limitation. We disagree, and find that substantial evidence supports the Board’s finding that the Tatsuzuki spring contacts the post at more than just a point. The Board reasoned that Tatsuzuki discloses that the spring is stamp cut, and does not disclose that the spring contacts the post at a point. J.A. 82. Moreover, the Board explained that “in [its] view, [the Tatsuzuki spring] has a length of contact with the post that is beyond a point.” J.A. 82. Figure 3 of Tatsuzuki supports this finding, as the spring depicted has visible width. *See* J.A. 1035.

CONCLUSION

For the foregoing reasons, we *vacate* the rejection of claims 10–25 of the ’060 patent and *remand*.

VACATED AND REMANDED

COSTS

Costs to PPC Broadband.